



**AUTHOR(S):**

**TITLE:**

**YEAR:**

**Publisher citation:**

**OpenAIR citation:**

**Publisher copyright statement:**

This is the \_\_\_\_\_ version of proceedings originally published by \_\_\_\_\_  
and presented at \_\_\_\_\_  
(ISBN \_\_\_\_\_; eISBN \_\_\_\_\_; ISSN \_\_\_\_\_).

**OpenAIR takedown statement:**

Section 6 of the "Repository policy for OpenAIR @ RGU" (available from <http://www.rgu.ac.uk/staff-and-current-students/library/library-policies/repository-policies>) provides guidance on the criteria under which RGU will consider withdrawing material from OpenAIR. If you believe that this item is subject to any of these criteria, or for any other reason should not be held on OpenAIR, then please contact [openair-help@rgu.ac.uk](mailto:openair-help@rgu.ac.uk) with the details of the item and the nature of your complaint.

This publication is distributed under a CC \_\_\_\_\_ license.

\_\_\_\_\_

# Solar Powered Charging Backpack

Jonas Taverne <sup>1</sup>, Firdaus Muhammad-Sukki <sup>1,\*</sup>, Ahmad Syahir Ayub <sup>2</sup>, Nazmi Sellami <sup>1</sup>, Siti Hawa Abu-Bakar <sup>3</sup>,  
Nurul Aini Bani <sup>4</sup>, Abdullahi Abubakar Mas'ud <sup>5</sup>

<sup>1</sup> School of Engineering, Robert Gordon University, Scotland, United Kingdom

<sup>2</sup> Department of Electronic & Electrical Engineering, University of Strathclyde, Glasgow, United Kingdom

<sup>3</sup> Universiti Kuala Lumpur British Malaysian Institute, Selangor, Malaysia

<sup>4</sup> UTM Razak School of Engineering and Advanced Technology, Universiti Teknologi Malaysia, Kuala Lumpur, Malaysia

<sup>5</sup> Department of Electrical and Electronic Engineering Technology, Jubail Industrial College, Saudi Arabia

---

---

## Article Info

## ABSTRACT

This paper demonstrated a step by step process in designing a solar powered charging backpack that is capable of charging a mobile phone efficiently. A selection of existing products available on the market were reviewed and compared to ascertain the cost, size, and output capabilities. Next, the solar cell types and regulators were compared and their respective merits were also investigated. The charging system was then designed and tested before being integrated with the backpack. The results clearly showed that the system managed to charge the mobile phone. However, it was found that the excessive power dissipation has caused the LR to generate significant heat.

---

### Keyword:

Solar cell  
Regulator  
Charging circuit  
Backpack  
Efficiency

---

---

## 1. INTRODUCTION

Solar is one of the most abundant sources of renewable energy, with the potential capability of generating enough power to meet the demands of the entire planet. It was calculated theoretically that the amount of sun received on earth for one day has the capability to meet the demand of the world for more than 20 years [1]. Despite the huge potential, solar photovoltaic only provides 1.2% of the world's electricity. The harnessing of solar energy is still very much ongoing with the advancements in solar technology constantly improving. There are many applications where solar energy is utilized - from the very big application, such as generating electricity for homes and industry from solar fields, to the very small applications like powering the calculators. The possibilities are extensive.

One of the products that utilises the solar energy is solar powered backpack. In terms of research, Malla et al. [2] analysed a solar powered backpack through buck boost converter to regulate the output voltage. They carried out various simulations in MATLAB to investigate the performance of their design, which showed good agreement when validated via experiments. Sulaiman et al. [3] investigated a solar-based wireless charging system and found that the mobile phone charged from this setup has superior standby time as compared to the wired charging system. Nahm [4] designed a solar backpack that comprised of 12 solar cell which was capable of charging a Blackberry Bold model 9780 by producing a minimum voltage of 4.2V and minimum current of 0.25A.

There are a varying number of products already on the market that utilise solar energy for storing and charging devices. The products range in all shapes and sizes from fully integrated to attachable. As with the product, there is also wide range in prices from the £30 mark to well over £200. A selection of the products is presented in Table 1. It should be noted that the prices obtained (22/02/2017) can be subject to change. It can be seen that all products use monocrystalline solar cell which had a stated conversion rate of 22%. Generally, the power of the solar backpacks was ranging from 6W to 7W with the output voltage of between 5V and 6V. The backpacks that come at greater cost tended to have a battery pack incorporated. The addition of this does increase the overall weight as expected.

The purpose of the paper is to develop a different prototype of solar powered charging backpack that is capable of charging a mobile phone efficiently. The design would have to meet certain criteria including durability, reliability, practicality and low cost. In order for this to be achieved successfully, research, design, testing and analysis are carried out.

Table 1. Selection of solar backpack in the market.

Sold By	Watts	Voltage	Battery Bank	Bag Size (L*W*H)	Weight	Price
	(W)	(V)		(cm)	(kg)	(£)
Vitechbiz [5]	6.5	6.0	No	35*22*52	1.30	90.00
TVCMALL [6]	6.5	6.0	No	55*36*23	1.35	40.40
ECEEN [7]	7.0	--	Yes (10AH)	65*60*30	2.00	139.99
Sunsky [8]	6.5	6.0	Yes	22*8.5*32	1.80	71.99
Glorysolar [9]	7.0	5.0	No	55*36*23	1.34	57.39

The design of the charging circuit and the solar cell will need to meet the requirements of the mobile phone. The phone that will be used as a test is Vodafone's Smart First 7. The battery is Li-ion with a capacity of 1400mAh, a nominal voltage of 3.7V and a charge up voltage of 4.2V. The phone operates a micro USB charger connection on the phone side and a USB version 2.0 connection to charger [10]. The charging circuit should have the appropriate compatible USB connection.

## 2. CHARGING CIRCUIT

Within a charging circuit it is necessary to have a regulated voltage output to supply the charging capabilities to the load. Therefore, it is important to look at the different types of voltage regulators available. The two main types are switching and linear. Switching regulators can be broken down into buck types (step-down), boost (step-up) and inverter types.

The main stipulation for the charging circuit is to regulate an output voltage of 5V to satisfy the charging requirement for the phone battery. When comparing the linear with the switching regulator it is important to establish the most practical circuit with relation to efficiency and cost. The switching circuits have higher complexity when it comes to the external components. In comparison, the linear circuits' external components are reduced due to the linear operation of the regulator. The reduction in complexity relates to a cheaper circuit cost. However, the switching types have higher efficiencies which are at the expense of circuit complexity. The switching types are also capable of boosting as well as operating in buck mode. Despite this, switching regulators have a higher output voltage ripple owing to their switching nature, produce electromagnetic interference (EMI) and noise and are generally more expensive than linear regulators [11].

The main advantage of the buck and boost converters is the efficiency rates which can be greater than 90% [11]. This is due in part to the inductor which provides current to the load during off periods of the MOSFET instead of dissipating its stored energy as heat. This is also the case for the capacitor which charges during on periods and then supplies the load during the off periods and once the inductor has discharged. Some of the main advantages of the linear type are a lower output voltage ripple, transient response to any changes with the load, and low EMI and noise. The low noise and low EMI is attributed to the non-switching characteristics of the circuit and no inductors in operation. Linear regulators (LRs) have some disadvantages relating to their low efficiency, heat sink is required, unable to step down voltage.

Taking the advantage and disadvantages into consideration, the LR will be used as the voltage regulator. This is due to the lower cost associated with the external circuitry and regulator itself, EMI and noise reduction, and low output voltage ripple [12]. Consideration into operating with a low dropout regulator (LDO) was taken and despite being more efficient than LR, it was not deemed feasible. This was based on the fact that the LDO operates with low voltage drops (typically in mV) [11]. This would become problematic when the weather conditions are such that the solar panel supply increases/decreases by one or more volts.

The circuit comprises of a voltage divider to regulate the output voltage. A diode was used to protect the solar cell from reverse charge of the battery. The circuit, once designed will undergo tests and improvements made if necessary.

The first and most important component is the LR. Following the specifications of the mobile phone battery it is necessary to have an output of 5V from the circuit as previously discussed. The input voltage will need to be of sufficient magnitude to allow for the regulated output voltage with relation to the minimum dropout voltage of the chosen regulator.

Several LR were looked at with relation to the adjustable output voltage range and the maximum output current. TS317CM was found to be suitable. The output voltage was adjustable over a range of 1.25V to 37V and a maximum output current of 1.5A for package type TO-220. The regulator has several key internal protection feature such as thermal overload, short circuit current limiting constant with temperature and output transistor safe area compensation [11]. With these internal protection features it meant that external protection circuitry was reduced.

As stated, the regulated output voltage is set by a voltage divider connected to the adjust pin of TS317CM.  $R_2$  can be a fixed resistor or a variable resistor to allow for variations of  $V_{out}$ .

LTspice was used as the simulation software package to verify the output voltage. This was achieved by setting the resistance values in accordance to the calculated values and running the simulation. The simulated circuit and corresponding results can be found in Figures 1 and 2.

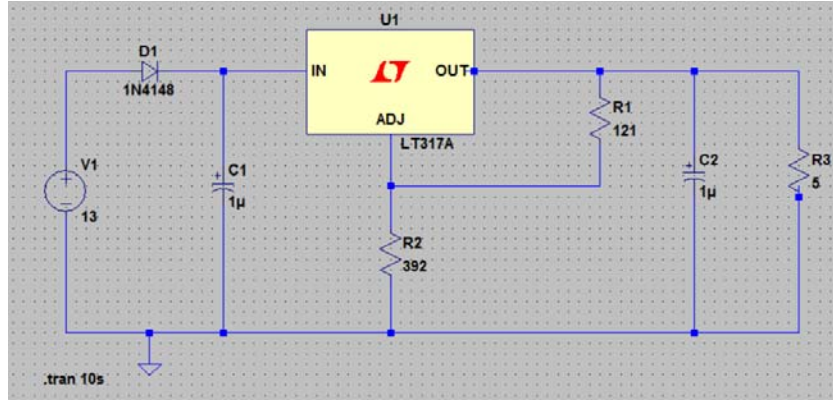

Figure 1. Simulated circuit design.

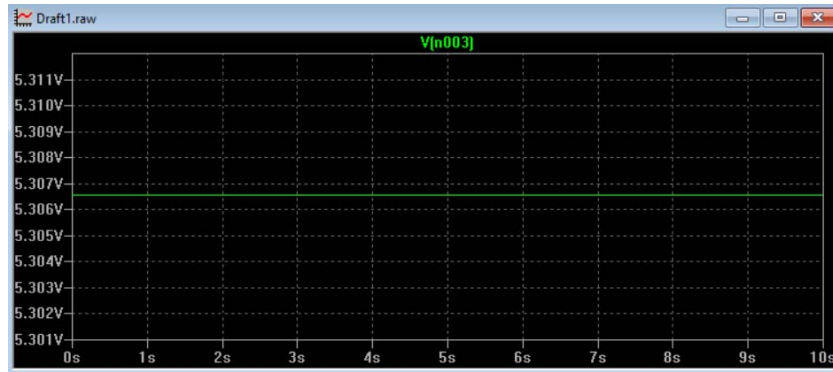

Figure 2. Simulated output voltage.

For simulation, a resistor was used as a load. Diode  $D_1$  protects against reverse charge from the battery. The diodes rating needs to have a breakdown voltage that will maintain the correct biasing throughout circuit operation. The diode chosen for the constructed circuit was 1N4004 as this was more than capable so satisfying the operational criteria [12].

The value of  $V_{out}$  was found from both calculation and simulation results. The equation used to find  $V_{out}$  as stated in the datasheet was the following [11]:

$$V_{out} = V_{ref} \left( 1 + \frac{R_2}{R_1} \right) + I_{adj} R_2 \quad (1)$$

where  $V_{ref} = 1.25V$ ,  $I_{adj} = 100\mu A$  ( $max$ ) with typical value =  $50\mu A$  [11], and  $R_1$  &  $R_2 = 121\Omega$  &  $390\Omega$  respectfully. The resistor ratio  $\frac{R_2}{R_1}$  was found from simplifying Equation 1 by neglecting the addition of  $I_{adj} R_2$  giving:

$$V_{out} = V_{ref} \left( 1 + \frac{R_2}{R_1} \right) \quad (2)$$

Equation 2 can then be rearranged to find  $\frac{R_2}{R_1}$  as shown in Equation 3.

$$\frac{R_2}{R_1} = \left( \frac{V_{out}}{V_{ref}} \right) - 1 \quad (3)$$

For an output voltage of 5V gives a ratio of 3, as shown:

$$\frac{R_2}{R_1} = \left( \frac{5}{1.25} \right) - 1 = 3 \quad (4)$$

The output voltage was then calculated using Equation 2 with all the parameters stated. The calculated result of  $V_{out} = 5.32V$  which was just over the required operating voltage of  $5V$  was acceptable. Through simulation  $V_{out}$  was shown to be  $5.31V$  as seen in Figure 2. It is clear to see from the specification that the results backup the calculated result.

An input capacitor will need to be used if the solar panel is connected an appreciable distance from circuit, as specified by the datasheet. The advantage of connecting a capacitor across the input ( $C_1$ ) will reduce the sensitivity to input line impedance [11]. Capacitor  $C_2$  improves the transient response of the circuit which is specified in the datasheet along with the value of capacitance [11]. The voltage tolerance of the capacitors is such that the voltage values are greater than the circuit voltages as to maintain full capacitance operation value.

### 3. SELECTION OF SOLAR CELL

Selecting the appropriate solar cell/panel depends mainly on efficiency and cost. Tables 2 provides some of the advantages and disadvantage of the three different solar cell types. It can be seen from Table 2 that, in terms of efficiency, monocrystalline is the most efficient with polycrystalline and amorphous cell following second and third respectfully. One of the main reasons for the amorphous type having a significantly lower efficiency is because, when compared to monocrystalline, it is still a fairly new technology [13]. However, it is still necessary as comparison to the more established types.

Table 2. Advantages and disadvantages of solar cells

Type of cell	Advantages	Disadvantages
Monocrystalline	High efficiency rates 15% to 20% Space efficient Long operational lifespan  Generally perform better than similar rated polycrystalline	Expensive Silicon waste during manufacture More efficient in warmer climates, decreased performance as temperature rises
Polycrystalline	Not as expensive as monocrystalline Less waste silicon	Not as space efficient as monocrystalline Efficiency rates of 13% to 16% due to lower silicon purity
Amorphous	Less silicon needed Substrates can be made from inexpensive material Can be sprayed on flexible and light material Performs relatively well under poor light/not affected by shading issues	Low efficiency rates of 10% to 12% Thin film tends to degrade faster Larger coverage needed than crystalline based cells Larger coverage needed than crystalline based cells

Monocrystalline has a lot of strong attributes, not only in high efficiency rates but also with its efficiency relating to space. With monocrystalline, the high rates of efficiency mean that the overall size of the cell/panel can be reduced. The general life-span of monocrystalline is greater than the other three types, given that manufacturers and sellers alike attaching a 25-year warranty [13]. The higher efficiency and longer life-span is represented in the cost, with monocrystalline being the more expensive.

Polycrystalline and amorphous types lack the higher efficiency rates of the monocrystalline. The space efficiency in the polycrystalline is less than that of the monocrystalline but does consume less silicon during manufacturing. The amorphous type, again, requires less material which is cheaper. The construction of amorphous solar cells makes them more flexible and lightweight. The operation of amorphous is such that it behaves 'good' under poor light and operates effectively in colder conditions [13].

The backpack that is to be used has an allowable amount of space which needs to come into consideration when the choice is made. This will also have an impact as the limited space will mean an efficient solar type will need to be selected. It is therefore determined that monocrystalline will be used. Despite the higher costs incurred, the reasons stated above outweigh the higher costs.

The rating of the solar cell/panel is determined by the type of voltage regulator (switching or linear) used in the charging circuit. As the selected regulator is of the linear type, there needs to be compensation for the minimum allowable voltage drop as stated by the regulator. Therefore, the rating of the solar panel needs to take this factor into consideration. The LR has an allowable minimum volt drop of  $2V$  which when added with the USB voltage of  $5V$  relates to a minimum panel rating of  $7V$ . After some consideration, two  $6V$   $6W$  rated monocrystalline solar cells connected in series are used to supply more than  $7V$  to the charging circuit.

### 4. TESTING

Initial testing of the circuit was carried out using the designed circuit to charge the mobile phone. The initial battery percentage was recorded and checked every 5 minutes over an appreciable period. The input and output voltages as well as the current to the load were recorded. The test was carried out under both cloudy and clear days to achieve a clear comparison of the operation of the circuit. During both test conditions the cells were placed as close to  $90^\circ$  to the sun as possible with no obstructions.



Figure3. Testing setup

Figure 3 shows the test setup. The testing was carried out in a number of days. The following is the test carried out was under cloudy weather conditions on date 06/04/017 in Aberdeen, Scotland. The panel is assume to be static, and was place in an open space with no shading from nearby buildings. The start charge of the battery was 2%. Figure 4 shows the increasing charge of the battery over the test time. As previous, there is little increase within the first twenty minutes of charge. Within the next forty minutes of charge there is a significant increase in the batteries capacity. From time, 16:05 onwards, the increase becomes more gradual as the battery capacity increases.

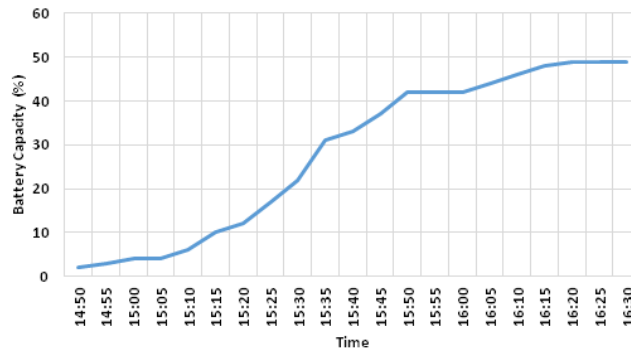

Figure 4. Battery capacity test.

As can be seen from Figure 5, the current did not deviate from its max output of 450mA throughout the test. This was due to the input voltage maintaining above the allowable volt drop of the circuit, as observed from Figure 6.

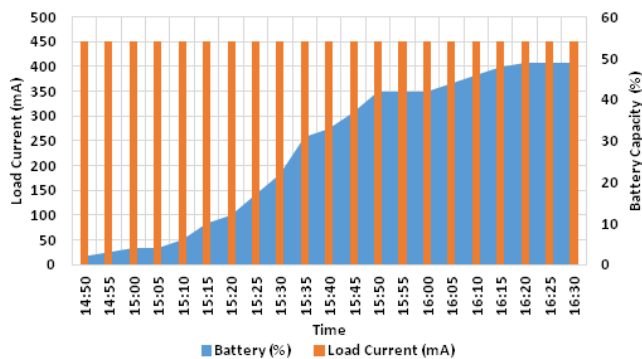

Figure 5. Load current test.

The efficiency can be calculated from the following Equation (5) [11]:

$$\eta_{LR} = \frac{P_{out}}{P_{out}-P_{Loss}} = \frac{V_{Out} * I_{Out}}{V_{Out} * I_{Out} + (V_{IN} - V_{Out}) * I_{Out}} = \frac{V_{Out}}{V_{IN}} \quad (5)$$

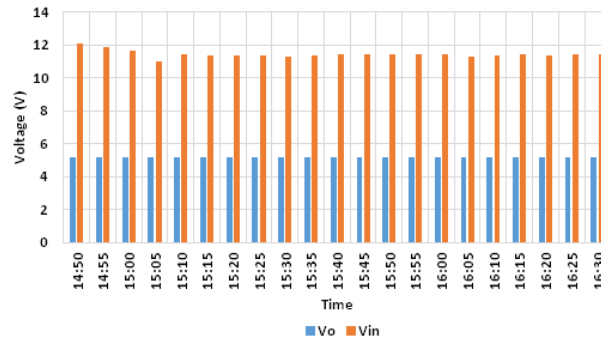

Figure 6. Input and output voltage comparison test.

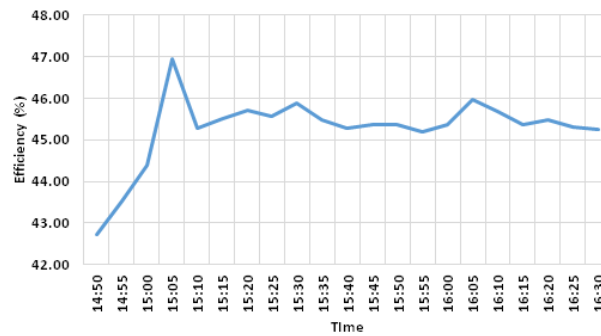

Figure 7. Efficiency test.

From Figure 7, it clearly shows the efficiency of the circuit to be around the 45.5% mark. The lowest efficiency was recorded a 42.73% and the highest at 46.96%. The result of which meant a large amount of power was dissipated as heat causing TS317CM to heat up significantly. The tests have shown that the circuit was successful in charging the phone. It is also clear to see the importance of matching the correct rating of cell to the characteristics of the circuit. The two cells test showed that the higher input voltages would result in lower efficiencies and cause excessive heating of the LR. In the future, it is suggested that a single cell is used to provide both the higher efficiencies and appropriate input voltage levels to maintain correct operation of the charging circuit.

## 5. INTEGRATION OF COMPONENTS

The most important consideration during integration is to maintain the integrity of the solar panel and charging circuit. The system needs to be robust but still operate effectively. The two main options for integration is either fully integrated or partially.

Requirements for full integration:

- Water-resistant
- Shock resistance
- Aesthetically acceptable

Requirements for partial integration:

- Easily attachable
- Small package footprint for storage
- Robust
- Aesthetically acceptable
- Water-resistant

---

There are several advantages and disadvantages to both systems. The benefit with a fully integrated system is that it comes as a complete package with no need to attach the panel. In contrast the partial method allows for the product to be removed completely if not in use. The product can then be stored safely without the possibility of getting damaged. Each cell used has the following dimensions: 165mm x 165mm. As stated above the system would have to adhere certain requirements.

The design that was looked at was using the 2 cells as shown in Figure 8. The design was meant to be such that the panels could be attached and removed when necessary. For this arrangement, a book like design was constructed. There were no costs during the design/construction of the integration process as all materials were recycled/re-purposed materials.

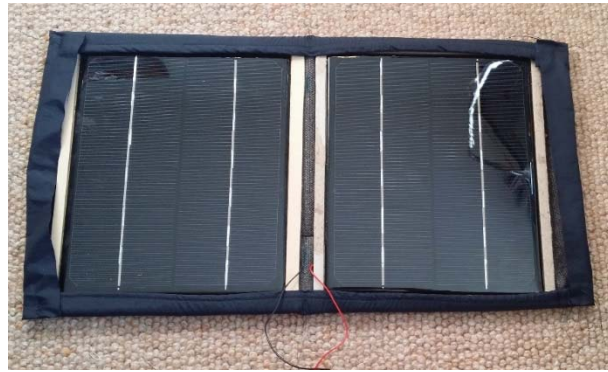

Figure 8. Two-cell series connection integration design.

The design could then be attached using Velcro straps. The panels are protected by a cardboard backing and edging to provide some shock absorption. The cardboard frame is enclosed in a denim material which will allow a degree of wear-and-tear. The whole panel design, when removed, can be folded and stored away protecting the panels. This design does have some disadvantages when it comes to overall size which does impact the aesthetics. However, there is the added advantage that this design can be removed and placed in the optimum position when stationary. An example of a final product of a solar powered charging backpack integration is presented in Figure 9.



Figure 9. Final product – using one cell integration.

## 6. CONCLUSION

There have been advances in solar technology with relation to the different solar cell; however monocrystalline still holds the higher efficiency rates which made it the logical choice when selecting the appropriate type. This was reflected in the research and tests carried out. It must be concluded that despite the higher efficiency ratings of monocrystalline, amorphous solar cells have the ideal physical properties with relation to flexibility. With greater efficiencies in amorphous cells would result in a more adaptable product.

The overall design and operation of the circuit managed to successfully charge the mobile phone with acceptable efficiency ratings. The circuitry was kept simple but effective as a result of utilising the LR. This meant that the cost was kept to a minimum.



The tests carried out under varying weather conditions clearly showed that the system managed to charge the mobile phone. However, it was found that the excessive power dissipation has caused the LR to generate significant heat. In the future, it is suggested that a single cell is used to provide both the higher efficiencies and appropriate input voltage levels to maintain correct operation of the charging circuit.

The integration of the system with the backpack was vital as the aesthetics of the final product was important to uphold. The choice of making the product a partial integration was due to versatility. The system could be removed and integrated with other backpacks easily making it a more attractable solution.

#### ACKNOWLEDGEMENTS

The author would like to thank Ministry of Higher Education (MOHE), Malaysia and Universiti Teknologi Malaysia (UTM) (Research cost centre no. Q.K130000.2540.16H95) for funding part of this project.

#### REFERENCES

- [1] Y. Chu, "Review and Comparison of Different Solar Energy Technologies," 2011.
- [2] S. G. Malla, D. J. Deepu, D. P. Kumar, and J. M. R. Malla, "Solar powered mobile phone: An innovative experiment," in *2016 International Conference on Signal Processing, Communication, Power and Embedded System (SCOPEs)*, 2016, pp. 1015–1020.
- [3] N. Sulaiman, M. S. Jadin, A. A. Hadi, M. S. Najib, M. A. Ahmad, and N. S. A. Yusuf, "Evaluation of Mobile Phone Wireless Charging System Using Solar and Inductive Coupling," in *Advances in Intelligent Systems and Computing*, M. Akagi, T. T. Nguyen, D. T. Vu, T. N. Phung, and V. N. Huynh, Eds. Springer, Cham, 2017, pp. 238–247.
- [4] A. Nahm, "The solar charging backpack," *The Menlo Roundtable*, vol. 10, no. 6, pp. 79–110, 2011.
- [5] Vitech Internet Limited, "Solar Backpack with 6.5W Mono Crystalline High Efficiency Solar Panel," 2017.
- [6] TVCMALL, "Polyester Solar Backpack Bag 6.5W 6V Solar Panel with 5V 1A Output," 2017.
- [7] ECEEN Ltd, "Solar Powered External Frame Pack," 2016.
- [8] Sunsky, "Portable and Fashionable Outdoor Solar Charger Backpack," 2017.
- [9] Glorysolar, "Glorysolar® 7Watts Solar Backpack/Solar Panel Bag /Solar Panel Charger for Mobile Phones," 2017.
- [10] GSMarena, "Vodafone Smart First 7," 2016.
- [11] H. J. Zhang, "Basic Concepts of Linear Regulator and Switching Mode Power Supplies," 2013.
- [12] ON Semiconductor, "1N4001 - 1N4007: General-Purpose Rectifiers," 2014.
- [13] M. A. Maehlum, "Which Solar Panel Type is Best? Mono- vs. Polycrystalline vs. Thin Film," *Energy Informative*, 2017.