

# Hydrogen energy storage.

ALI, D.M.M.

2019

# Hydrogen Energy Storage

*Dallia Mahmoud Morsi Ali*

## Abstract

The dominating trend of variable renewable energy sources (RES) continues to underpin the early retirement of baseload power generating sources such as coal, nuclear, and natural gas steam generators; however, the need to maintain system reliability remains the challenge. Implementing energy storage with conventional power plants provides a method for load leveling, peak shaving, and time shifting allowing power quality improvement and reduction in grid energy management issues, implementing energy storage with RES smooth their intermittency, by storing the surplus in their generation for later use during their shortfall, thus enabling their high penetration into the electricity grid. Energy storage technologies (EST) can be classified according to many criteria like their application (permanent or portable), capacity, storage duration (short or long), and size (weight and volume). EST suited for short duration storage and low-to-medium power outputs are seen performing better in improving power quality, while those providing medium-to-high power outputs with long durations are seen better suited for energy management of electrical networks. With the growing deployment of renewable energy systems, EST must be utilized to allow the grid to absorb the increased integration of RES generation. The recent advances in hydrogen energy storage technologies (HEST) have unlocked their potential for use with constrained renewable generation. HEST combines hydrogen production, storage, and end use technologies with the renewable generation either in a directly connected configuration or in an indirectly connected configuration via the existing power network. This chapter introduces the hydrogen energy storage technology and its implementation in conjunction with renewable energy sources. The efficiency of renewable hydrogen energy storage systems (RHES) will be explored with a techno-economic assessment. A levelized cost (LC) model that identifies the financial competitiveness of HEST in different application scenarios is given, where five scenarios are investigated to demonstrate the most financially competitive configuration. To address the absence of a commercial software tool that can quickly size an energy system incorporating HEST while using limited data, a deterministic modeling approach that enables a quick initial sizing of hybrid renewable hydrogen energy systems (HRHES) is given in this chapter. This modeling approach can achieve the initial sizing of a HRHES using only two input data, namely the available renewable energy resource and the load profile. A modeling of the effect of the electrolyzer thermal transients at start-up, when operated in conjunction with an intermittent renewable generation, on the quantity of hydrogen produced is also given in this chapter.

**Keywords:** hydrogen energy storage technology, renewable hydrogen energy storage systems, levelized cost modeling, sizing hybrid renewable hydrogen energy system for a specified demand and renewable resource, modeling the effect of the electrolyzer thermal transients at start-up when powered by renewables on the quantity of hydrogen produced

## 1. Introduction

The green-house gas emissions associated with conventional electricity generation will lead to an increase in the average global temperature over the upcoming years, which in turn will lead to raised sea levels and more frequent extreme weather conditions and droughts. To mitigate such global climate changes, the world needs an energy transition that allows a cleaner and more sustainable energy supply.

The decarbonization of the world's energy system has started in 2015 after the signature of the legally binding agreement by 195 countries to keep the global warming well below 2°C [1]. Since then, significant amounts of RES have been installed and integrated into the grid while securing the supply and the system resilience. Expanding the utilization of RES into the electricity grid however requires large-scale electricity storage to cover for their energy intermittency. Even a small-scale grid that handles only 10–30 gigawatts could not rely entirely on intermittent RES without having a gigawatt-scale storage that can work for many hours; so, for example, securing 3 GW for 2 days requires a 144 gigawatt-hours storage. There are many storage options; some of these are the flow batteries, which store the energy directly in the electrolyte, but are still in an early stage of deployment; sodium-sulfur batteries, with higher energy density than Li-ion ones; however, their hot liquid metal electrolyte is inconvenient; supercapacitors, which cannot provide electricity over a long enough time; and compressed air and flywheels have made it only to small and midsize installations due to location restrictions. Hydrogen energy storage however offers a clean, sustainable, and flexible storage option that can be scaled up to enable large-scale energy storage over long periods of time with no restrictions on location, and therefore it has the potential to enable the energy transition. While the transition toward using more variable RES into the power grid will unbalance the supply and demand, using the excess in the RES power supply in electrolysis to produce hydrogen and store it for future use during RES supply deficit can help balancing the grid. The stored hydrogen can also be used in other sectors like transport, industry, residential heat, etc. Implementing hydrogen energy storage with renewables therefore have the potential to improve the economic efficiency of renewable investments, enhance the security of power supply, and serve as a carbon-free seasonal storage supplying energy when the RES production is low or the energy demand is high.

This chapter explores the context of hydrogen as an energy vector and the role of hydrogen energy storage in the world energy transition. An exploration into the hydrogen technology techno-economic potential, its applications, achievements, and challenges to its deployment as well as recommendations for accelerating its deployment are covered in this chapter. This chapter also includes a model that has been developed to enable the quick sizing of a hybrid renewable hydrogen energy system (HRHES) that integrates solar and wind renewable resources combined with hydrogen energy storage to meet a specific electrical load. The effect of the electrolyzer thermal transients at start-up, when operated in conjunction with the intermittent renewable generation, on the quantity of hydrogen produced is included in the developed model. Implementing the developed model as a tool for identifying the performance issues within installed hydrogen systems during their operation is also given in this chapter. Two case studies are provided to verify the developed model, and to validate that thermally compensated electrolyzer models are essential for designing new hydrogen installations as well as for monitoring the performance issues within running installations.

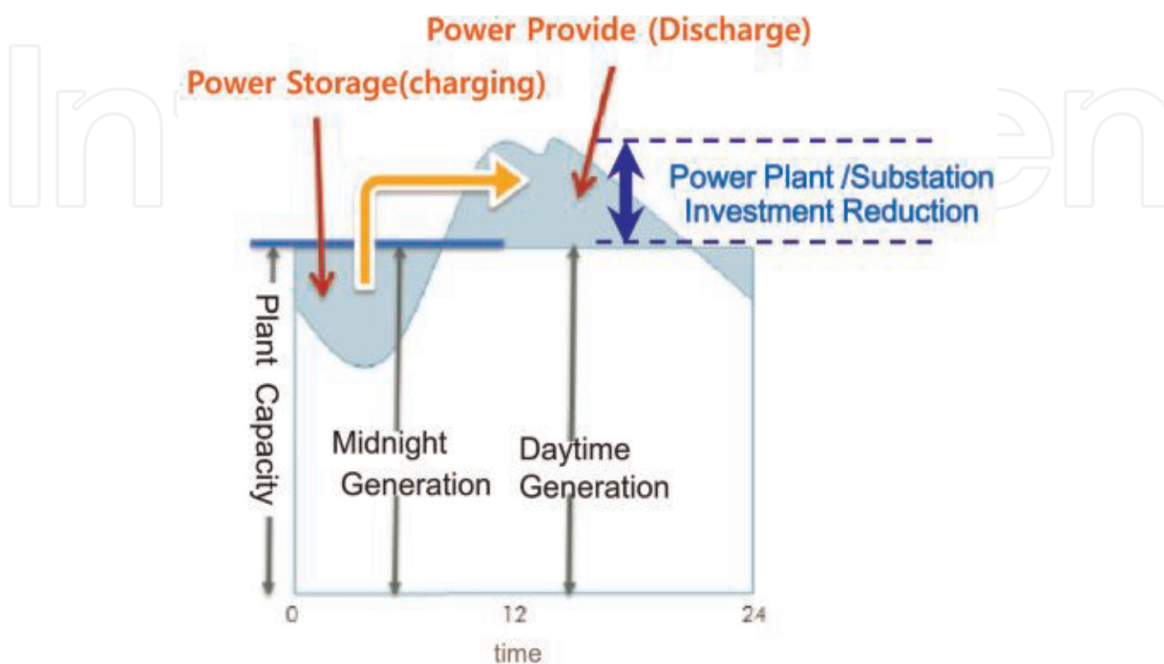
## 2. Preface: role of energy storage in the world energy transition

Twenty-four percent of the global green-house gas emissions are produced from the electrical power generation sector [2]. Implementing RES into the power generation sector can play a vital role in reducing this emission percentage and accordingly address the climate change with its associated political, economic, and environmental pressures [3]. To enable the high penetration of fluctuating RES into the electrical power network, the network should be able to absorb and store the excess in the power fed so that they remain stable and should utilize the RES generation in the most possible effective manner. Delivering the RES generation to the load when needed and to the storage when the generation exceeds consumption allows the absorption of the excess in RES generation and thus reduces the need for the grid weak interconnections upgrading and remove a considerable amount of constraint issues. Additionally, implementing energy storage reduces the spinning reserve requirements and thus allows spinning reserve operational costs to be diverted to the EST operational costs [4].

The flexibility that the storage brings to the grid reduces the electrical supply and demand imbalance associated with increased RES integration, and thus facilitates energy transition. While the inclusion of energy storage brings some additional capital and operational costs together with energy conversion loss efficiencies [5] and although there is limited experience with implementing large-scale energy storage technologies (except for pumped hydro), the implementation of EST is still considered vital for enabling the projected increase of RES into the power network as a step toward achieving the energy transition [6].

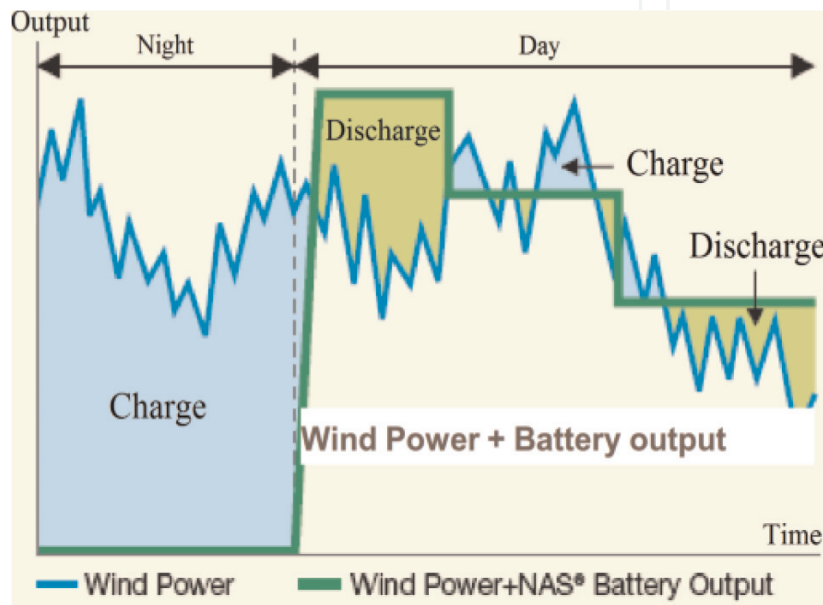
### 2.1 The need for energy storage in modern power systems

Energy storage increases the power grid capacity in accommodating the increasing fluctuations in supply and demand, and thus it plays a crucial role in supporting the wider integration of distributed RES in modern electrical networks [7]. Integrating EST into electrical networks allows more flexibility in accommodating the increased amounts of RES [8].

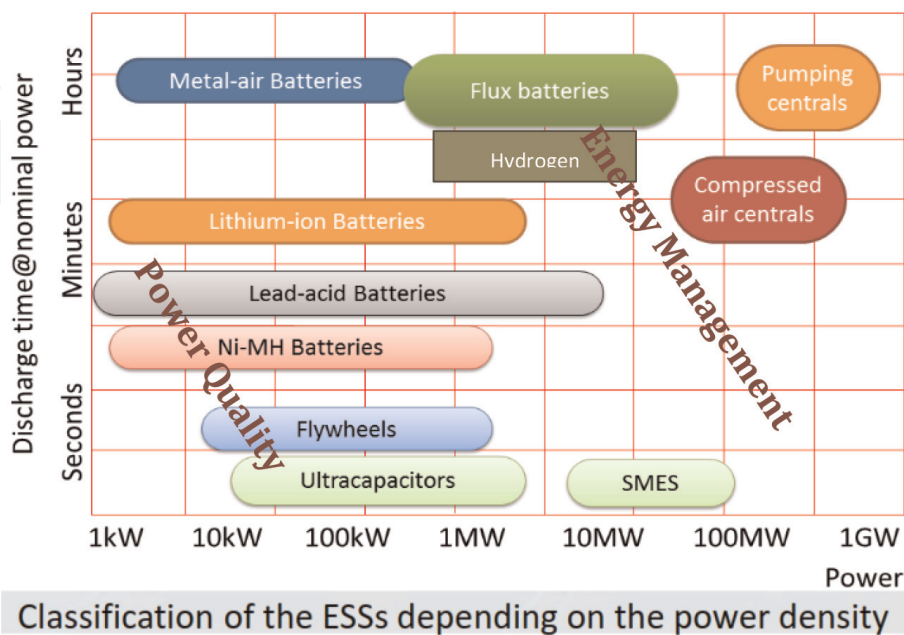


**Figure 1.**  
*Energy storage for Load Leveling and Peak Shaving.*

In power systems, energy storage provides a method for “Load Leveling” by storing the power during periods of light loading and delivering it during periods of high demand, thus avoiding the high costs during peak demand and postponing investments in grid upgrades or in building new generating capacity. It also provides a method for “peak shaving,” which works like load leveling but aims to reduce the peak demand. Energy storage can also be used for “time shifting” by storing the energy during low price times, and discharging it during high price times. All these actions allow reduction in the grid’s energy management issues and improve the power quality. **Figure 1** depicts how energy storage allows load leveling and peak shaving with conventional power plants, and **Figure 2** depicts how implementing bulk energy storage with intermittent RES facilitates their high



**Figure 2.**  
Energy storage with RES to enable their high grid penetration.



**Figure 3.**  
Energy storage technology overview, Scottish Government Report [10]. \*SMES = superconducting magnetic energy storage.

penetration into the electricity grid through storing the surplus in their energy to be used later to match the fluctuating load demand curve.

Energy storage is crucial for many applications and while implementing them in large size at the supply side can assist in the network bulk energy management, implementing them distributed near the consumer can assist in reducing power quality issues. EST energy storage duration ranges from few seconds of operation to several hours [9]. **Figure 3** shows a summary of the different storage technologies with the applications in which they are best suited as conducted by the AEA technologies for the Scottish Government [10].

It can be seen from **Figure 3** that energy storage technologies that are best suited for short duration storage and low to medium power outputs are typically seen as performing better in improving the power quality, while EST that provide medium to high power outputs with long durations are better suited for the energy management of electrical networks.

### **3. Context for hydrogen as an energy vector**

Traditionally, the electrical network infrastructure has been designed to deliver electricity from several large-scale centralized fossil-fuelled electrical power stations to several domestic, industrial, and commercial consumers through a transmission network that is suited for power flow in one direction from generation to load. The hydrocarbon-fuelled and nuclear power stations are conventionally load following and can adjust their electrical generation output to follow demand, and thus the electrical grid maintains its equilibrium. When the network experiences any imbalance condition, the network operators implement control mechanisms to return the network to its balanced state. So, when generation cannot meet demand, the spinning reserve is connected to the electrical network and is loaded up according to demand. However, spinning reserve is a highly costly, carbon intensive, and inefficient method for maintaining the network stability as it requires the generating stations to remain running and consuming fuel to be brought online very quickly when needed to maintain the supply and demand balance.

The admission of the RES into the grid provides genuinely green energy at the points of entry; however, it creates a huge operational problem in managing the central generators to cover any transient variations in the renewable power input and consumer demand, thus hindering the renewable potential. The power network operators will have to manage the imbalance by either increasing the operation of the spinning reserve leading to increased costs [11], or by implementing other ways different from what they use with traditional power stations [12]. So, owners of RES connected to an increasingly congested electrical transmission and distribution network will have to incur financial penalties when they produce power at times of low demand and the network operators will have to pay compensations to RES owners when they introduce constraints [13]. An example of this is what happened at Scotland in April 2014, when strong winds made the Scottish grid not able to absorb all the wind power generated and had to constrain it off the grid while paying compensations to the owners of wind generators. Approximately £890,000 was paid over few hours to six wind farms.

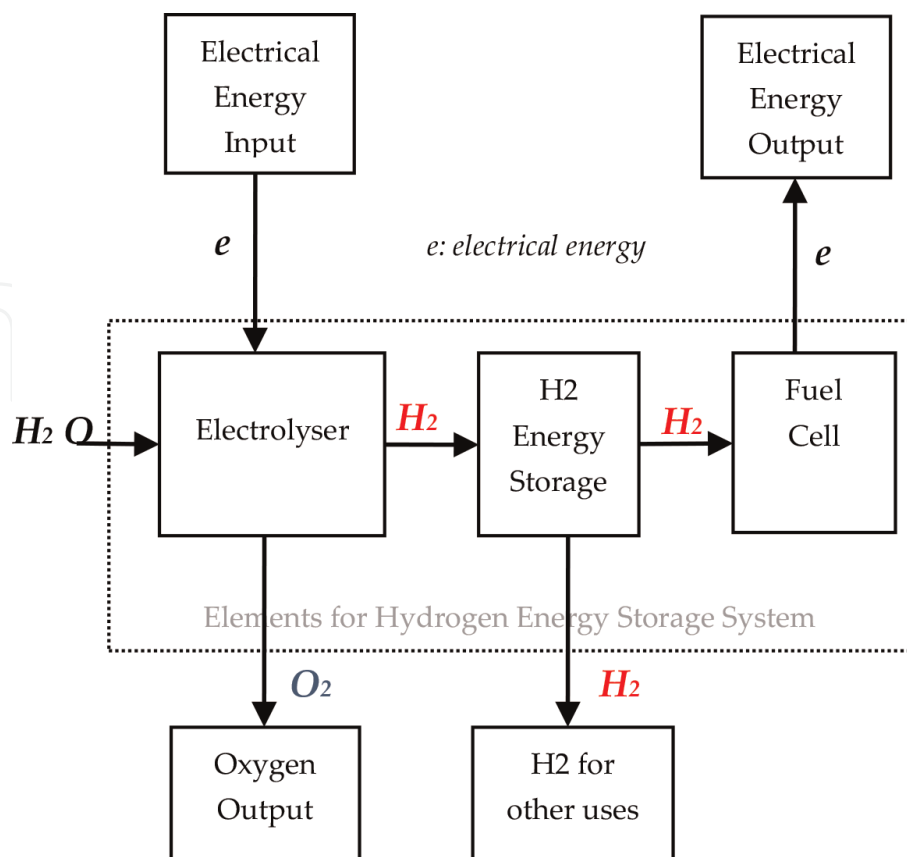
Given that the global renewable energy contribution (excluding bio-fuels) is predicted to increase by over 50% between 2010 and 2035 [14], the electrical power networks therefore need to have the capacity to store the excess power fed into the grid from fluctuating and intermittent power sources [15]. The electrical power networks also need to continually achieve equilibrium under the increasing demand conditions while reducing their dependence on the expensive and inefficient

spinning reserve, and thus it is crucial to increase their capacity through the implementation of energy storage technologies [16]. Therefore, it can be concluded that implementing EST is essential in modern power grids.

Hydrogen energy storage technologies are slowly but surely unlocking the potential of RES. Integrating HEST into the power networks not only allow the absorption of excess energy from fluctuating RES, but also allow the supply of supplementary energy needed when the RES production is insufficient to meet demand. Thus, HEST enable balancing the supply and demand while allowing the increased implementation of variable output RES.

#### 4. The hydrogen energy storage technology

Chemical energy storage in the form of hydrogen (gas or liquid) has the potential to store energy over long periods of time and can be scaled up with no restrictions on its location. Hydrogen can be used as an energy carrier, stored and delivered to where it is needed. The storage mechanism does not have high rate of self-discharge or degradation in performance. The basic elements of a hydrogen energy storage system (HESS) can be recognized in **Figure 4**. The electrolyzer (hydrogen generator) is used to convert the electrical energy from an energy source (typically renewable) into hydrogen for storage. The hydrogen storage system can store the hydrogen in several forms (pressurized gas, metal hydride, or liquid Dewar tank). A hydrogen energy conversion system then converts the stored chemical energy in the hydrogen back to electrical energy while giving off water and heat as by-products with no carbon emissions. The hydrogen energy conversion system that is commonly used is the fuel cell, given that its typical average electrical conversion efficiency, as recorded for installed projects, ranges between 40 and



**Figure 4.**  
Basic elements of a hydrogen energy storage system (HESS).

50% compared with a maximum of 37% for a small combustion engine [17]. Alternatively, the stored hydrogen can be used for other end uses and thus hydrogen and oxygen gases are sold as commodities.

#### **4.1 Challenges to the hydrogen energy storage deployment**

A key barrier to realize the potential of hydrogen energy storage systems is the limitation in the available modeling software and tools [18]. Another challenge is the ability to quantify the energy capacity and economic viability of the hydrogen energy storage technology (HEST) when integrated into the electrical power grid to enable the projected increase of renewables. Addressing these challenges is the main key for accelerating the wide deployment of the hydrogen technology.

#### **4.2 Potential of the hydrogen energy storage technology**

##### *4.2.1 Role of hydrogen energy storage in allowing increased integration of renewable energy generation in constrained power networks*

Hydrogen, as a form of energy storage, can deliver a fuel for making power or heat or for fueling a car while absorbing the intermittent power inputs from RES. Hydrogen production systems (electrolyzers) can be operated as deferrable and controllable loads within a smart grid infrastructure to allow the absorption of increased renewable energy generation in constrained power networks. The stored hydrogen can be used later in generating electricity when needed, or it can be used in other energy intensive sectors such as the gas grid, transport as a fuel, and industrial processes. Hydrogen storage is not geographically restricted and offers the potential to shift constrained renewable generation into other energy intensive sectors.

Large industrial and commercial consumers can play a vital role in balancing the grid through the intelligent use of their electrical loads while implementing hydrogen production and storage technologies. One example which demonstrates that hydrogen technology can be used for balancing the grid is what happens in “Tessengerlo Group,” a company which utilizes both oxygen and hydrogen gases in its chemical processing activities [19]. Tessengerlo utilizes one of the world’s largest scale hydrogen production systems, in the order of multiple Mega Watts (MW) scale [20, 21], and is charged at a lower cost/kWh in return to allow the local distribution network operator (DNO) to adjust its electrolytic hydrogen and oxygen production in maintaining the electrical network in the balanced state [22]. The DNO makes these adjustments in accordance with the demands on the electrical network using demand side management (DSM) techniques. The hydrogen production is reduced when the electrical network is experiencing a period of high demand and low energy production, and increased when the generation in electrical network exceeds consumption. Such a trading arrangement with a preferential tariff minimizes the need for the local network operators to waste money on highly inefficient spinning reserves. So, while utilizing the electrolyzer in maintaining the grid balance both hydrogen and oxygen gases are produced to be used in the chemical processes.

##### *4.2.2 Position of the hydrogen energy storage technology*

Hydrogen is in a strong position to be applied widely as an energy storage vector for balancing the grid while increasing the RES integration. Over the last decade, several renewable hydrogen concepts have been investigated [23] and several



installations have been implemented to demonstrate the role of energy storage in the form of hydrogen in balancing the supply and demand in constrained grids. Many of these installations were based around small-scale RES of only a few tens of kilowatts, with exceptions to the hydrogen mini grid system (HMGS) in Rotherham, the Yorkshire [24, 25], the Utsira (Norway) energy system [26], and the Hydrogen Office [27], where large-scale RES have been utilized. All these systems have utilized commercially available alkaline electrolyzers with rated hydrogen production capacity in the range of 0.2–10 Nm<sup>3</sup>/h and operating pressures in the range of 7–20 bar, except the Hydrogen Office electrolyzer of 3.5 Nm<sup>3</sup>/h at 55 bar.

Hydrogen storage technologies can be divided into physical storage, where hydrogen molecules are stored (this includes pure hydrogen storage via compression and liquefaction), and chemical storage, where hydrides are stored. While chemical storage could offer high storage performance due to the strong binding of hydrogen and the high storage densities, the regeneration of storage material remains an issue with a large number of chemical storage systems still under investigation.

Demonstration projects have showed that hydrogen has a flexibility with RES, which is not available in other energy storage technologies. It has been found out that energy storage employing hydrogen technologies is best suited with renewable energy sources through the absorption of their surplus generation via electrolysis and storing it in the form of compressed hydrogen gas for later re-use in many applications such as the following:

- Controllable generation reserve via fuel cells and/or gas turbines and/or internal combustion engines (ICE)
- Fuel for transport applications
- A means to transfer the renewable energy into the gas grid
- A chemical process gas for other end uses in food, fertilizers, etc.

As the governments around the world are strategically moving toward a low carbon economy, hydrogen storage will undoubtedly play an important role in making use of the grid constrained “green” energy within a rapidly growing market [28].

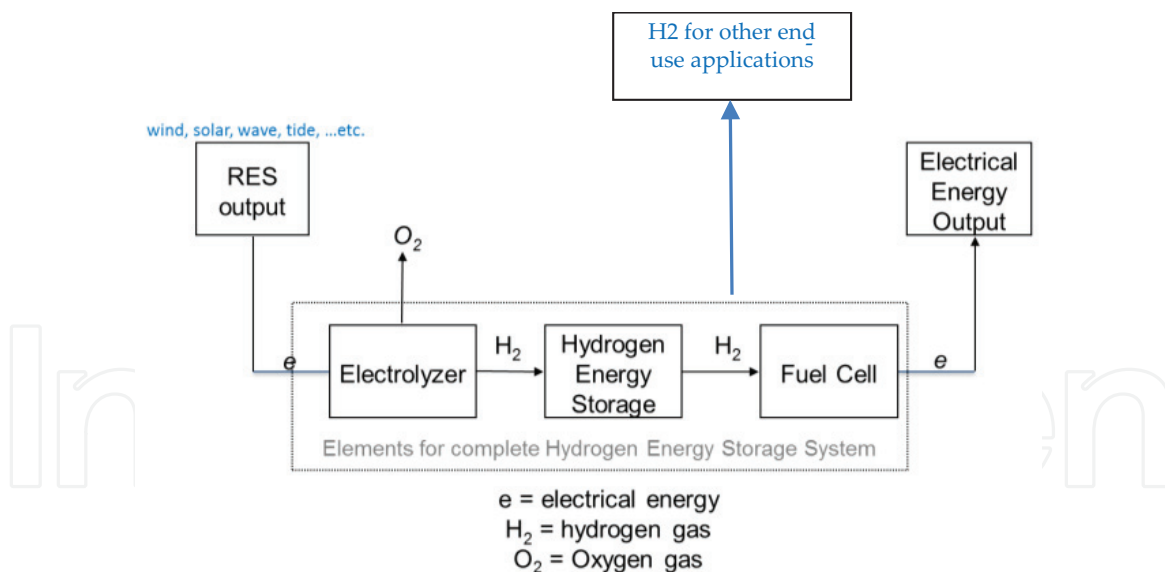
#### 4.2.3 Opportunities of the hydrogen energy storage technology

Hydrogen can be stored for long periods of time without degradation. Hydrogen can be stored in a gaseous or liquid form, or in some instances adsorbed onto a solid form in the case of metal hydride storage technology. Hydrogen is mixable with other gases making it suitable for mixing into the existing natural gas grid in a process known as sector shifting [29]. Additionally, hydrogen can be used as reactive agent in the chemical transformations of synthetic natural gas and fuels.

Hydrogen is seen by many of the energy industry experts as a mean of storing the surplus renewable energy from sources such as wind, solar, wave, and tide [30, 31] for later use. It is also seen to have a market potential for vehicle fueling in both urban and remote rural areas [32, 33].

#### 4.2.4 Additional benefits of the hydrogen energy storage technology

It can be noticed from **Figure 3**, which has overviewed the different storage technologies together with the applications in which they are best suited as conducted by the AEA technologies for the Scottish government, that hydrogen has



**Figure 5.**  
*Implementing hydrogen energy storage with RES.*

a role to play in durations between several minutes to hours and is best suited for applications larger than 100 kW, and thus can be identified as appropriate for the Energy Management of Electricity Networks.

HES, when compared to the other ESTs, is seen to be suitable for use with RES [34]. In summary, the stored hydrogen produced during the RES excess generation periods can be:

- injected into the gas grids (since it is mixable with other gases);
- used to generate electricity and heat via a fuel cell;
- used to power a fuel cell (FC) or a combustion engine' vehicle; or
- used in many industrial processes (like fertilizer production)

**Figure 5** overviews the implementation of hydrogen energy storage with RES.

#### 4.2.5 Limitations toward the adoption of the hydrogen energy storage technology

Despite of the benefits and potential that HEST presents, the high capital cost and the low turn-around efficiency (i.e., electricity to hydrogen stored then back to electricity) are two noteworthy limitations [35]. Significant efforts are being made by industry to address cost and efficiency concerns. Additionally, many countries have started the process of publishing draft guidelines for the use of hydrogen energy storage technologies [36].

To contribute to the effective and wider implementation of the hydrogen technology, especially where HESS are operated in combination with variable RES, appropriate financial mechanisms and effective modeling techniques are developed in this chapter.

## 5. Techno-economic assessment of hydrogen energy storage

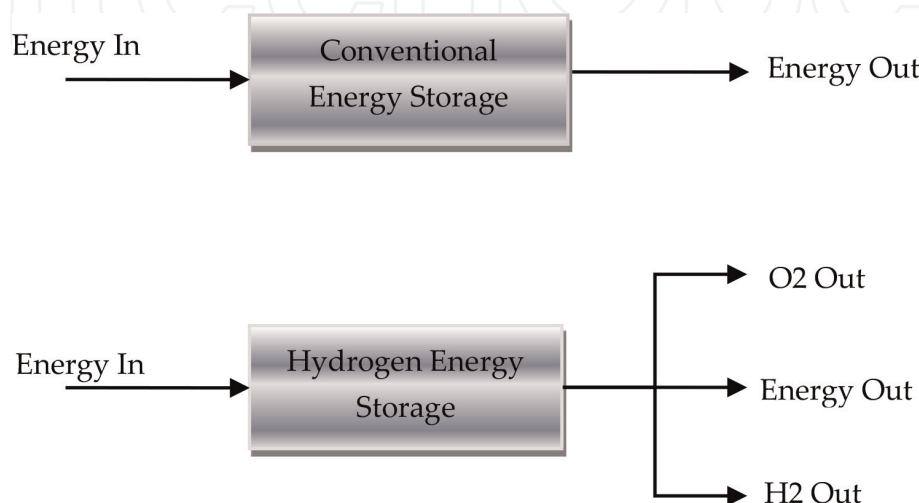
Energy storage technologies are generally compared in terms of their lifetime, efficiency, energy density, power density, and technological-maturity [37].

They are also often compared based on application-specific benefits and specific characteristics of interest [38, 39]; however, such comparisons did not take into consideration their financial competitiveness.

Financial competitiveness of EST is to define the price of stored energy per kWh over the lifetime of the energy storage system. The Electric Power Research Institute (EPRI) has developed and documented a method that analyses the costs associated with grid connected energy storage applications [40]. The EPRI utilizes a levelized cost model (LCM) approach to perform the cost benefit analysis for energy storage technologies. The LC, in its basic form, is calculated by dividing the annual expenditures by the annual income and correcting for inflationary effects. The LC reflects the capital and operational expenditures including the upfront capital costs, the fuel expenses, the operating and maintenance (O&M) charges, the financing costs, etc. levelized cost analysis is often used in regulatory review and longer-term resource planning [41]. Levelized costs can be done using limited input data, thus useful for evaluating technologies with limited operating experience or available data.

The HEST has not been included in the EPRI analysis [42] or in other cost analysis modeling techniques available in literature. HEST appears to be commonly excluded from the cost comparative studies due to its high capital cost and low turn-around efficiency compared to other bulk ESTs. Even the studies that examined HEST have not included its additional revenue streams. So, a study that has been completed by the National Renewable Energy Laboratories (NREL) has introduced the value of grid connected stored hydrogen for transport applications [43], but did not consider the potential value of the oxygen gas as a by-product from electrolysis. Since the by-product oxygen would either have a positive or a negative effect on the cost competitiveness of HEST, therefore, a new LCM is developed in this section to explore this.

**Figure 6** illustrates the economic revenue streams of both the conventional and hydrogen energy storage technologies. While conventional energy storage systems allow for energy to be stored and released in the form of electrical energy, hydrogen as an energy storage mechanism allows surplus RES electrical energy to be stored and released as electricity in addition to hydrogen and oxygen gases that could be sold as commodities offering greater financial competitiveness. Since this could offset the HEST low energy efficiency and high capital costs, it is considered in the developed HEST financial competitiveness model.



**Figure 6.**  
HEST possible economic revenue streams compared to conventional EST.

## 5.1 The proposed levelized cost model (LCM) for HEST

The costs of energy storage are considered using a levelized cost of ownership approach. Typically, the capital costs of an energy storage facility are expressed as €/kW installed, where it includes all expenses involved in the purchase and installation of facility. The €/kW capital expenditure (CapEx) multiplied by the size of the facility produces the total cost of the project. In the proposed model, all the costs related to an energy storage facility are expressed as (i) total €/kW of usable discharge capacity (in kW) and (ii) total €/kWh of usable energy storage capacity. EST with deeper Depth of Discharge (i.e., the ability of an ESS to release its stored energy) and higher turn-around efficiency (i.e., ratio between input energy and output energy) will have a lower unit cost of usable power and energy [44].

Using the levelized cost approach, the levelized storage cost (LSC) of energy storage technology can be expressed as shown in Eq. (1) [41]:

$$LSC = \frac{\sum_{t=1}^n \frac{ISC_t + SOM_t + EC_t}{(1+r)^t}}{\sum_{t=1}^n \frac{EO_t}{(1+r)^t}} \quad (1)$$

where  $ISC_t$  is the invested storage capital in year (t);  $SOM_t$  is the storage operation and maintenance costs in year (t);  $EC_t$  is the input energy cost (t);  $r$  is the annual discount rate (typically 10%); and  $EO_t$  is the value of released energy in year (t).

The LSC for the hydrogen storage technology will have additional revenue potential realized in the sale of both hydrogen and oxygen gases as a commodity. Equation (1) is therefore expanded to include  $H_{2t}$  and  $O_{2t}$ , and the LSC is expressed as shown in Eq. (2):

$$LSC = \frac{\sum_{t=1}^n \frac{ISC_t + SOM_t + EC_t}{(1+r)^t}}{\sum_{t=1}^n \frac{EO_t + H_{2t} + O_{2t}}{(1+r)^t}} \quad (2)$$

where  $H_{2t}$  is the value of sold hydrogen gas year (t) and  $O_{2t}$  is the value of sold oxygen gas in year (t).

To evaluate the economic competitiveness of hydrogen energy storage systems utilizing the “surplus” or “grid constrained” renewable energy generation, several configurations are considered here to conclude the most economic scenario.

**Scenario 1:** Selling 100% of the hydrogen and oxygen gases produced by electrolyzer, and no electricity to sell (i.e., no fuel cell electricity generation).

**Scenario 2:** Selling 100% of the  $H_2$  gas stored as electricity injected back to the power grid through the FC electricity generation (i.e., no  $H_2$  gas to sell), and selling 100% of the  $O_2$  gas.

**Scenario 3:** Selling 50% of the produced hydrogen as gas while the other 50% is sold as electricity to the grid via the fuel cell, and selling 50% of the oxygen as gas while the remaining 50% is vented to the atmosphere (i.e., not making use of half the produced oxygen value).

**Scenario 4:** Selling 100% of the hydrogen as gas (i.e., no fuel cell generation and no electricity to sell) and no selling of oxygen gas (i.e., not making use of all the produced oxygen value).

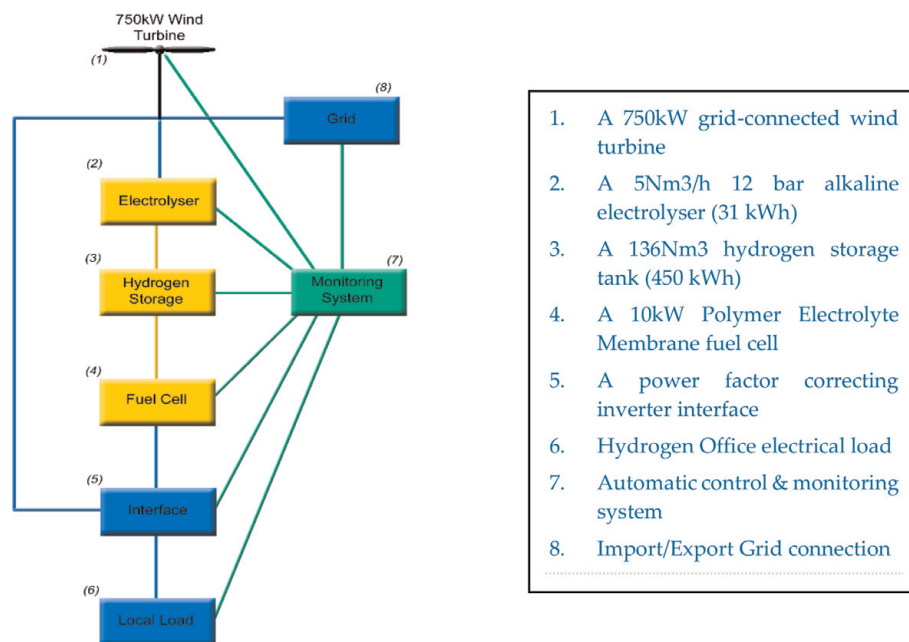
**Scenario 5:** Selling 100% of the stored hydrogen as electricity back to the power grid (i.e., no  $H_2$  gas selling), and no  $O_2$  gas selling (i.e., not making use of all the produced oxygen value).

Note that, Scenarios 4 and 5 do not utilize the by-product oxygen gas.

These five scenarios are tested on the “hydrogen office” energy storage system, as a case study, and the levelized cost per unit output is calculated for each scenario using Eq. (2). The Hydrogen Office, in Methil Docks Business Park in Scotland, employs a wind/hydrogen energy storage system that has been installed to demonstrate the potential of HES in storing surplus renewable energy. The Hydrogen Office’s main components are shown in **Figure 7**, the Capital expenditure (CapEx) and Operational Expenditure (Opex) data are given in **Table 1**, and the market value for the by-product H<sub>2</sub> and O<sub>2</sub> gases is given in **Table 2** [34].

**Figure 8** shows the LSC results for the five scenarios. It can be seen from figure that the most financially competitive configuration for the hydrogen energy storage technology is realized in Scenario 1. A favorable result is also seen in Scenarios 2 and 3. The least competitive configuration is seen in Scenario 5 when none of the gases is sold as commodity. Although hydrogen has a high financial value when sold as a gas, Scenario 4 demonstrates that it is not competitive when sold on its own.

It can be concluded from **Figure 8** that the hydrogen energy storage technology has a great potential and financial benefit in enabling the projected increase of renewable generation into the electrical network as it allows alternative economic pathways for



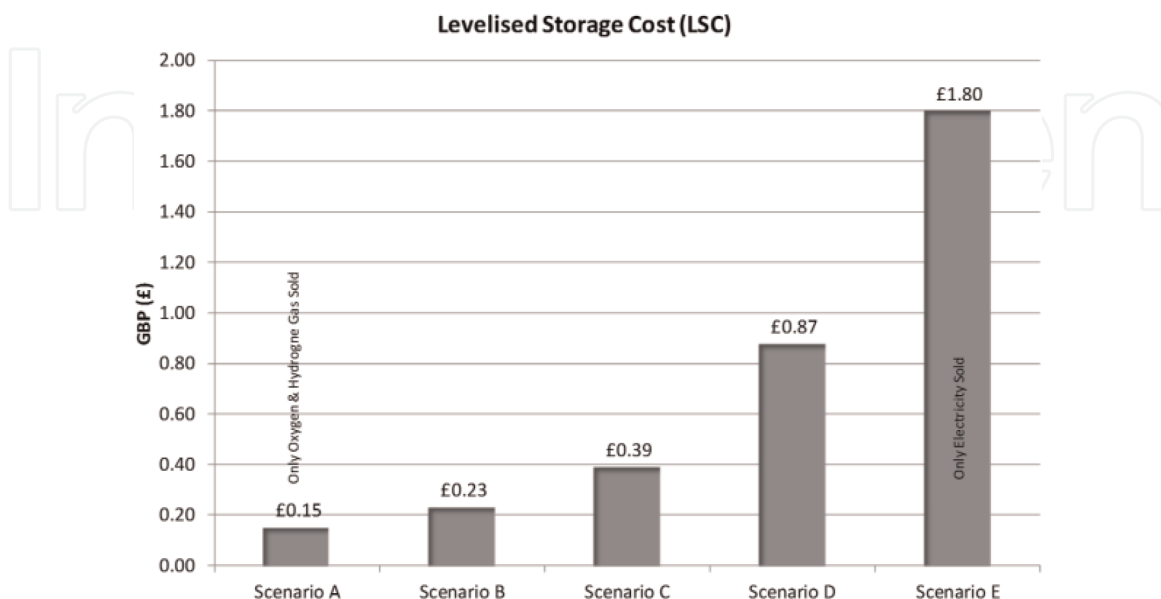
**Figure 7.** The Hydrogen Office simplified system overview.

CapEx & OpEx data	
Hydrogen CapEx	
Electrolyzer (€/kW)	€ 2500.00
Storage (€/kWh)	€ 27.00
Fuel cell (€/kWh)	€ 4000.00
Hydrogen OpEX	
Electrolyzer (€/kW)	€ 50.00
Storage (€/kWh)	€ 2.00
Fuel cell (€/kW)	€ 100.00

**Table 1.** HEST capital and operational expenditure data.

Market data	
O <sub>2</sub> Sale (€/Ton)	€ 3000.00
H <sub>2</sub> Sale (€/Ton)	€ 5000.00

**Table 2.**  
 Market value for hydrogen and oxygen gases.



**Figure 8.**  
 The LCM simulated output costs for the HEST scenarios.

the surplus renewable generation. The stored hydrogen is not only limited for electricity production, but can also be sold for another end uses. Moreover, HEST has the most economic potential when its by-product oxygen is sold as well.

The HEST levelized cost is then compared to the levelized costs of other conventional energy storage technologies as obtained from a research conducted by NREL and summarized in **Table 3** [45]. **Figure 9** illustrates this comparison.

It can be seen from **Figure 9** that CAES and PHS are more cost competitive than the five HEST scenarios proposed. This shows that there is still a need for reducing the HEST CapEx or increasing its turn-around efficiency to increase its financial competitiveness. However, HEST can compete with NaS and RFB technologies when it is used in conjunction with the oxygen gas by-product selling. Additionally, HEST competes with NiCd battery technology when only 50% of the oxygen gas is sold and half the hydrogen is sold as gas and the other half as electricity. HEST is not competitive when used for only selling electricity (Scenario 5) or only selling H<sub>2</sub> gas (Scenario 4) without selling the O<sub>2</sub> gas.

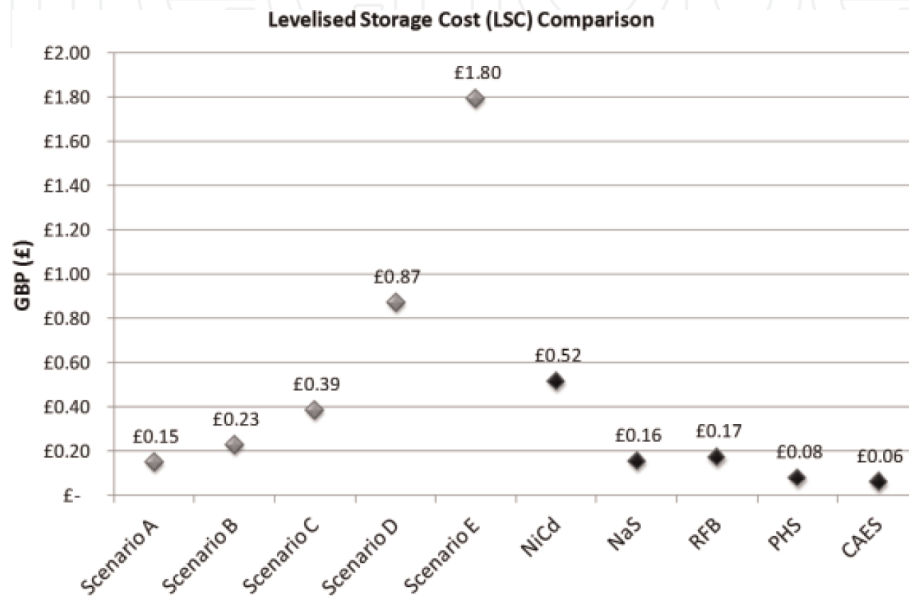
## 5.2 Efficiency of renewable hydrogen energy storage systems (RHESS)

All energy storage systems have varying degrees of inefficiency (turn-around efficiency), with typical efficiency ranging from 45 to 80%. Hydrogen energy storage systems' efficiency can be considered higher especially when implemented with RES because of the following:

- The efficiency of electrolysis is high.
- They commonly utilize a fuel cell that has a conversion efficiency a lot higher than that of the combustion engine technology.

Technology	Levelized storage cost (LSC)
NiCd battery	€ 0.52
NaS battery	€ 0.16
Radox flow battery (RFB)	€ 0.17
Pumped hydrostorage (PHS)	€ 0.08
Compressed air energy storage (CAES)	€ 0.06

**Table 3.**  
Levelized costs of other energy storage technology [45].



**Figure 9.**  
The levelized cost of HEST versus the levelized costs of other conventional energy storage technologies.

- Their efficiency can be increased by utilizing the output heat from electrolyzers and fuel cells in process heating.
- When utilized with RES, they capture and store the excess in renewable energy that would have otherwise been dumped and this in turn adds to their efficiency.
- They do not only store the electrical energy for future re-use like all other conventional ESS, but also allow both hydrogen and oxygen gases to be sold as commodities thus increasing the system economic efficiency. The 3:1 increase in revenue options, shown in **Figure 6**, opens the potential for downstream applications like car fuelling, fertilizer production, and high and low-grade heat applications in addition to electricity.

## 6. Sizing a hybrid renewable hydrogen energy system (HRHES)

The available sizing models are either Commercial software (like EMCAS, EnergyPLAN, energyPRO, GTMax, IKARUS, Invert, MiniCAM, NEMS, ORCED, PERSEUS, ORCED, PERSEUS, PRIMES, ProdRisk, RAMSES, RETScreen, SIVAEL, STREAM, WASP, and WILMAR [46, 47]) or standalone modeling techniques. The commercially available software does not offer simulating the HEST as part of a

hybrid renewable energy system, and those which can [like HOMER, BALMORAL, H<sub>2</sub>RES, ENPEP-BALANCE, HYDROGEMS (incorporated into Transys16), SimREN, and UniSyD3.0] require a significant quantity of input data and substantial computing resources to perform well and still some of them are not capable of sizing the hydrogen energy system. The more advanced standalone modeling techniques, like genetic algorithms (GA), particle swarm optimization (PSO), and simulated annealing (SA) need significant computing resources.

To address the large input data requirements of the commercially existing software and the significant computing resources needed by advanced GA, PSO, and SA techniques, a new deterministic sizing methodology that offers a rapid initial system sizing of a hybrid renewable hydrogen energy system (HRHES) with the minimal amount of input data and computer resources is given here. This simple technical sizing technique, referred to as deterministic [48, 49], can provide a rapid and reasonably accurate system sizing [50] while using limited number of input data. This approach can therefore play an important role at the initial design phase of HRHES.

## 6.1 The developed deterministic sizing algorithm

To demonstrate the proposed new deterministic sizing methodology that offers a rapid initial system sizing of a hybrid renewable hydrogen energy system (HRHES) with the minimal amount of input data and computer resources and thus supports its initial design, a HRHES sizing model is developed here based on the presence of solar and wind as the renewable resources combined with HEST to meet the demands of an electrical load. The outline of the developed deterministic sizing algorithm is shown in **Figure 10** and is detailed in the following subsections.

### 6.1.1 Sizing the integrated renewable energy sources (wind turbine and solar photovoltaic)

The first criterion in sizing a HRHES is sizing the renewable energy sources (RES). The objective of including the RES generation into the sizing routine is to minimize the difference between the average load demand ( $\bar{P}_{dem}$ ) and the average renewable energy generation ( $\bar{P}_{gen}$ ). Typically, the duration of the analysis is 1 year to allow incorporating the seasonal variation of the demand and renewable generation. In the developed model, the wind turbine is considered as the primary renewable energy source and the photovoltaic (PV) as the secondary. Hence, the capacity factor for each technology is first determined.

The capacity factor ( $CF$ ) is defined as the average power output ( $\bar{P}$ ) from the renewable device as a percentage of the maximum power output ( $P$ ). The capacity factor of a wind turbine ( $CF_{wind}$ ) is given by Eq. (3), and that for a PV ( $CF_{PV}$ ) is given by Eq. (4).

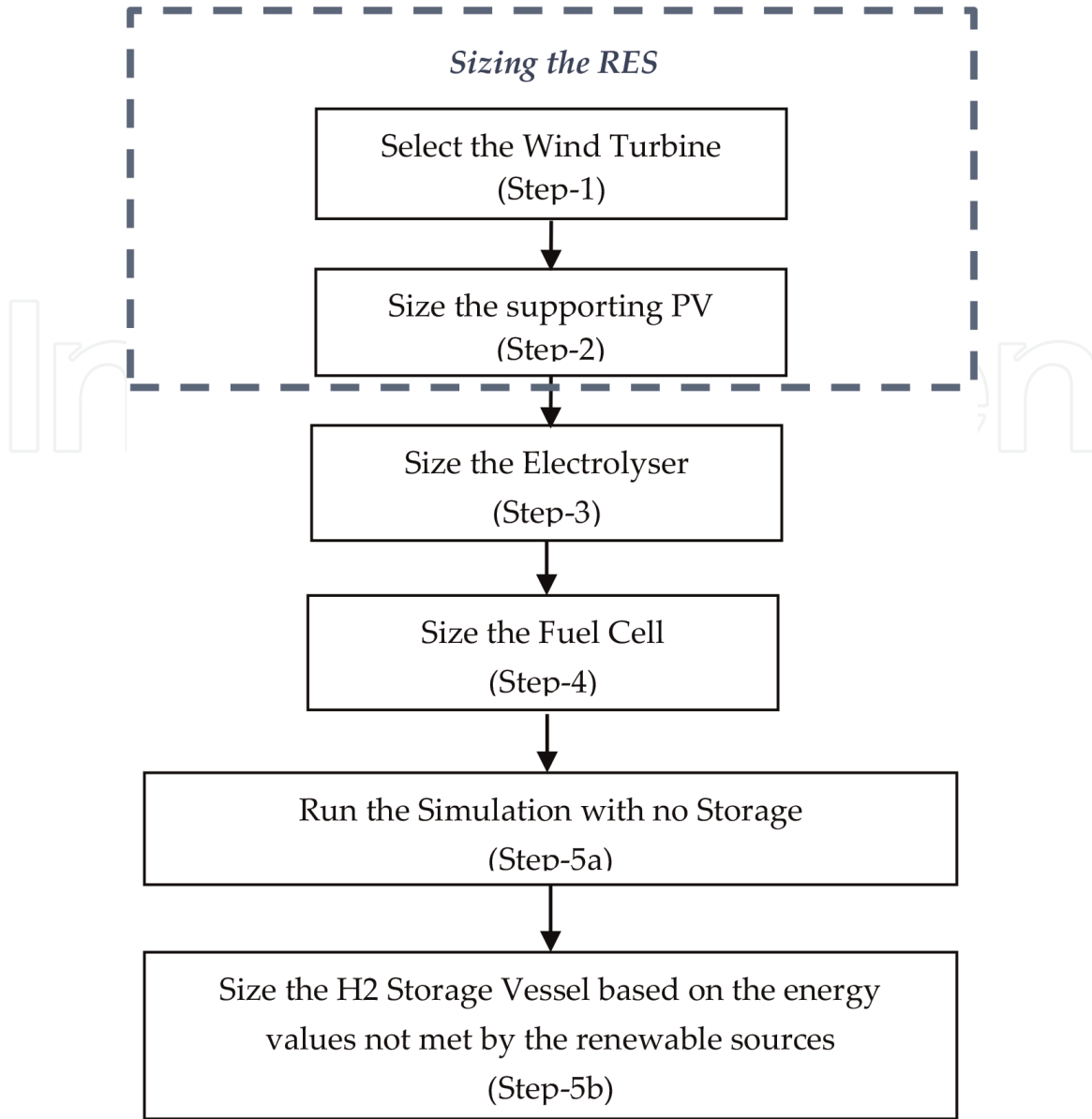
$$CF_w = \frac{\bar{P}_w}{P_w} \quad (3)$$

$$CF_{PV} = \frac{\bar{P}_{PV}}{P_{PV}} \quad (4)$$

where  $\bar{P}_w$  and  $\bar{P}_{PV}$  are the average power outputs from the wind turbine and the PV, respectively, while  $P_w$  and  $P_{PV}$  are their rated power outputs.

Given that sizing the wind turbine is usually restricted to the unit sizes available in the market, which in general are 3, 5, 6, 10, 15, 20, 50, 250, 330, 500, 850, 900,





**Figure 10.**  
The proposed deterministic sizing algorithm.

1200, 2200, 3200 kW, and thus the wind turbine is sized first. The average power of the wind turbine ( $\bar{P}_w$ ) is first selected to be close to the average demand of the defined load ( $\bar{P}_{dem}$ ); i.e.,  $\bar{P}_w \cong \bar{P}_{dem}$ .

The rated power output for the wind turbine is then calculated using the proposed wind turbine model given by Eq. (5). Note that, the annual average site wind speed is calculated using Eq. (6) and the wind turbine rotor coefficient of performance ( $C_p$ ), which is a measure of wind turbines blade rotor effectiveness at converting the power in the wind to mechanical power, is calculated using Eq. (7).

$$P_w = \left( \frac{1}{2} C_p \rho A v^3 \right) \quad (5)$$

$$v = 1 + S_{var} \cos \left( t_{hr} \left( \frac{360}{8760} \right) \left( \frac{\pi}{180} \right) \right) \exp \left\{ \left( - \left( \frac{\bar{v}}{C} \right)^k \right) \right\} \quad (6)$$

$$C_p(\lambda) = 0.5(\lambda - 0.02\beta^2 - 2.9)e^\lambda - 0.0303\lambda \quad (7)$$

where  $\lambda$  is the tip speed ratio, ratio of the wind speed, and the speed at which the wind turbines rotor tips are traveling, and it is found using Eq. (8); and  $B$  is the blade's pitch angle.

$$\lambda = \frac{\pi n D}{60 v} \quad (8)$$

where  $n$  is the turbine RPM;  $D$  is the turbine rotor diameter; and  $v$  is the wind speed.

The second step is to define the rated power of the supporting PV array ( $P_{PV}$ ) using Eq. (9). In Eq. (9),  $P_{PV}$  is calculated by using the values obtained from Eqs. (3)–(5).

$$P_{PV} = \frac{\bar{P}_{dem} - (CF_w P_w)}{CF_{PV}} \quad (9)$$

### 6.1.2 Sizing the electrolyzer (hydrogen generator)

After sizing the RES, the size of the electrolyzer ( $P_{EL}$ ) is calculated by subtracting the minimum load demand ( $P_{dem\_min}$ ) from the total rated power that can be delivered by the renewable energy sources. However, it has been found out that such a size can be very large and underutilized and because electrolyzers can be very expensive, it is desirable to operate them with a high level of utilization. Reducing this calculated value by around 50% [51], as shown in Eq. (10), increases the electrolyzer level of utilization but there will be times when the total renewable generation exceeds the total power that can be absorbed by the load and the electrolyzer of the RHESS.

$$P_{EL} = (P_{PV} + P_{wind} - P_{dem\_min})/2 \quad (10)$$

### 6.1.3 Sizing the fuel cell

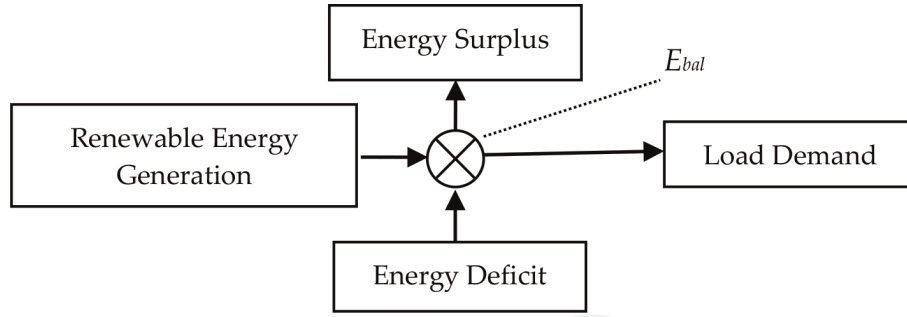
When the load demand exceeds the renewable generation, this deficit is met by the fuel cell generation. The fuel cell converts the chemical energy of the stored hydrogen into electrical energy to supply the demand. The fuel cell size is selected to meet or exceed the load maximum power demand ( $P_{dem\_MAX}$ ). Typically, a margin of 20% is added to the size of the fuel cell to accommodate any modest increase in peak demands [50]. The fuel cell power output ( $P_{FC}$ ) is therefore calculated as shown in Eq. (11).

$$P_{FC} \cong 1.2(P_{dem\_MAX}) \quad (11)$$

### 6.1.4 Sizing the hydrogen storage tank

The RES are first sized to supply a specified load on an annual average basis using Eqs. (3)–(9). Sizes of the appropriate electrolyzer and fuel cell are then identified using Eqs. (10) and (11). Because there could be times when there is no or insufficient renewable generation to supply the demand, assessing the correlation of the load demand and renewable generation is therefore needed. Simulating the energy system without storage, as shown in **Figure 11**, using the load and calculated sizes for PV and wind turbine allows to identify the correlation between the load demand and renewable generation.

The difference between the load demand and the renewable generation at different timings can be found by subtracting the load demand from the renewable



**Figure 11.**  
 Simulating the system without energy storage.

resource value for each recorded sample. Summing the differences for all the sample intervals yields a negative value, indicating a supply deficit, which defines the energy storage size. Equation (12) defines the size of energy storage ( $E_S$ ) needed to cover this deficit.

$$\bar{E}_S = \sum E_{bal} < 0 \quad (12)$$

The hydrogen storage tank must be sized to hold enough hydrogen for the fuel cell to deliver the energy requirements ( $\bar{E}_S$ ), thus the average fuel cell conversion efficiency is considered. Therefore, the energy that is required to be stored within the hydrogen storage tank ( $\bar{E}_{tank}$ ) can be defined as shown in Eq. (13).

$$\bar{E}_{tank} = \bar{E}_S \cdot \frac{1}{\bar{\eta}_{FC}} \quad (13)$$

where  $\bar{\eta}_{FC}$  is the fuel cell conversion efficiency considering the lower heating value (LHV) of the hydrogen gas.

The average volume of hydrogen ( $\bar{V}L_{tank}$ ) that needs to be stored in the hydrogen tank is then calculated, based on the absolute energy content of the hydrogen gas, using Eq. (14). The absolute energy content of the hydrogen gas is known as the higher heating value (HHV) of the hydrogen gas which is known to be 3.55 kWh/Nm<sup>3</sup> [52].

$$\bar{V}L_{tank} = \frac{\bar{E}_{tank}}{3.55} \quad (14)$$

## 7. Modeling the effect of thermal transients on the hydrogen production of renewably powered electrolyzers and utilizing the developed model as a tool to identify performance issues within operational hydrogen systems

A great challenge that faces the application of renewable-powered hydrogen energy storage systems is the ability to accurately determine the hydrogen production of an electrolyzer running on RES. Other challenges include their high costs and the need to guarantee their reliable and safe operation. A way forward toward achieving cost reduction is to lower their operation and maintenance costs by improving the hydrogen production efficiency and the system performance [53]. To achieve this, while ensuring safe system operation, the HES system must be able to handle the hydrogen gas securely and any leak must be quickly identified. If this is

not the case, any leakage will impact the overall system efficiency and the operation cost and could result into a potential safety hazard as well.

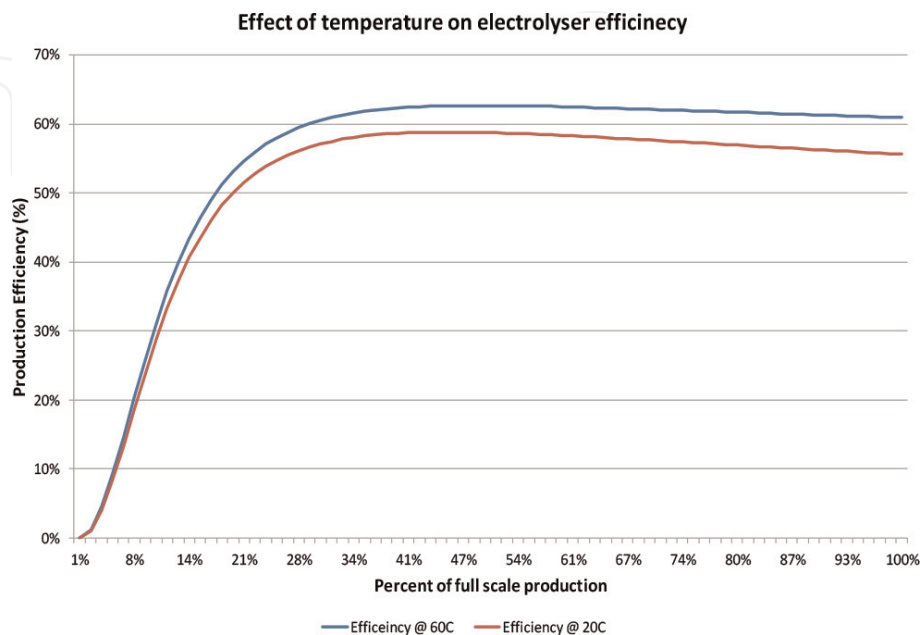
To address these challenges, a model that includes the thermal compensation effect to accurately simulate the hydrogen production from an electrolyzer fed by RES is developed in this section. The developed thermally compensated electrolyzer model can also be used as a tool to detect any H<sub>2</sub> leakage and identify performance issues within an operational electrolyzer. The developed model, when implemented on working HES systems, allows the identification of hydrogen leakages without the need for maintenance inspection thus reducing the operating costs.

Ignoring the effect of temperature on the electrolyzer hydrogen production, as the case with HOMER, may lead to unrealistic simulation results because the electrolyzer production efficiency at lower temperatures is lower than that at full production temperature. This result has been illustrated when the developed model was implemented on a 30 kW electrolyzer, as a case study, to simulate the effect of temperature across its full range of hydrogen production. **Figure 12** demonstrates the impact of heat compensation on the electrolyzer hydrogen production efficiency.

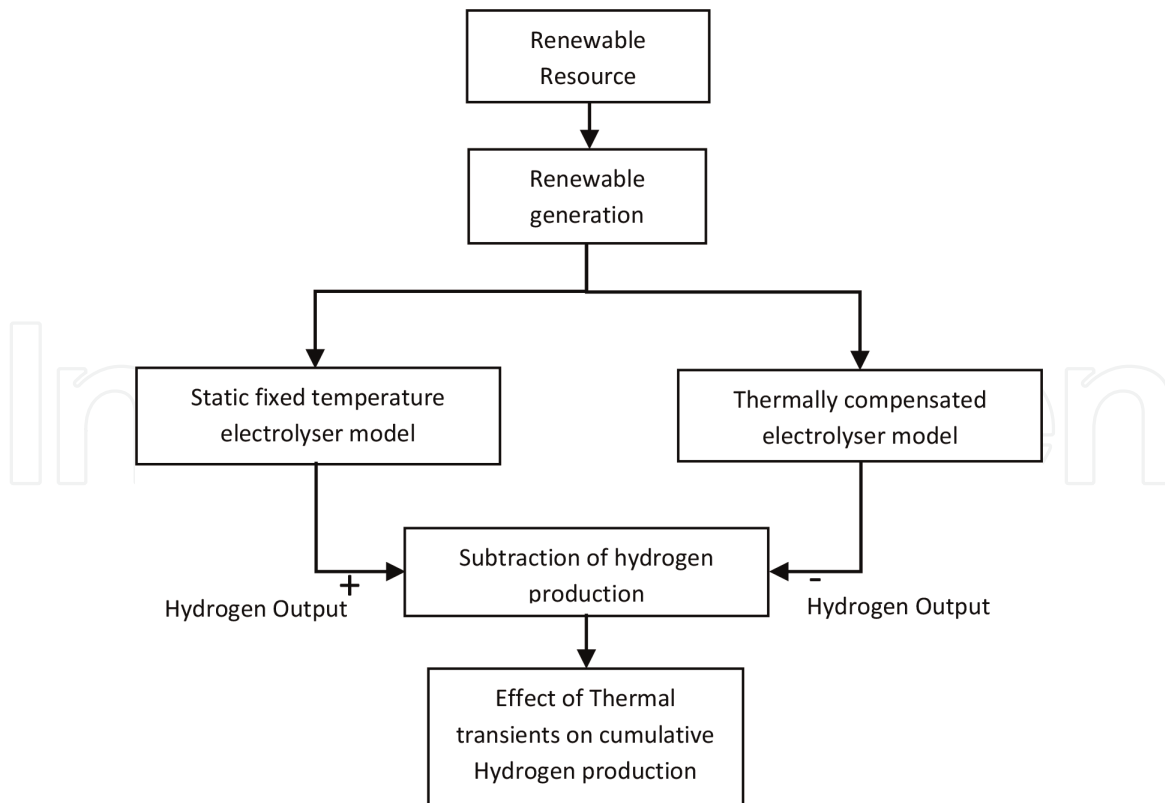
The developed model is based on the combination of heat transfer theory, fundamental thermo-dynamics, and empirical electrochemical relationships, as measured from operating systems. The developed model is detailed in the following subsections.

### 7.1 The algorithm proposed for identifying the effect of thermal transients on the electrolyzer hydrogen production

To identify the effects of thermal transients on the overall hydrogen production from an electrolyzer, a three-step algorithm is developed as shown in **Figure 13**. The first step involves simulating the hydrogen production from a renewable-powered electrolyzer with the electrolyzer model compensated using the effects of temperature on its hydrogen production. The second step involves repeating the simulation, but with the electrolyzer temperature fixed at its full working temperature (i.e., effects of thermal transients ignored). In the final step, the overall effect of thermal transients on hydrogen production is calculated by subtracting the step 1 hydrogen



**Figure 12.**  
*Impact of heat compensation on the efficiency of a 30-kW electrolyzer.*



**Figure 13.** Proposed algorithm to identify the impact of thermal transients on the electrolyzer hydrogen production.

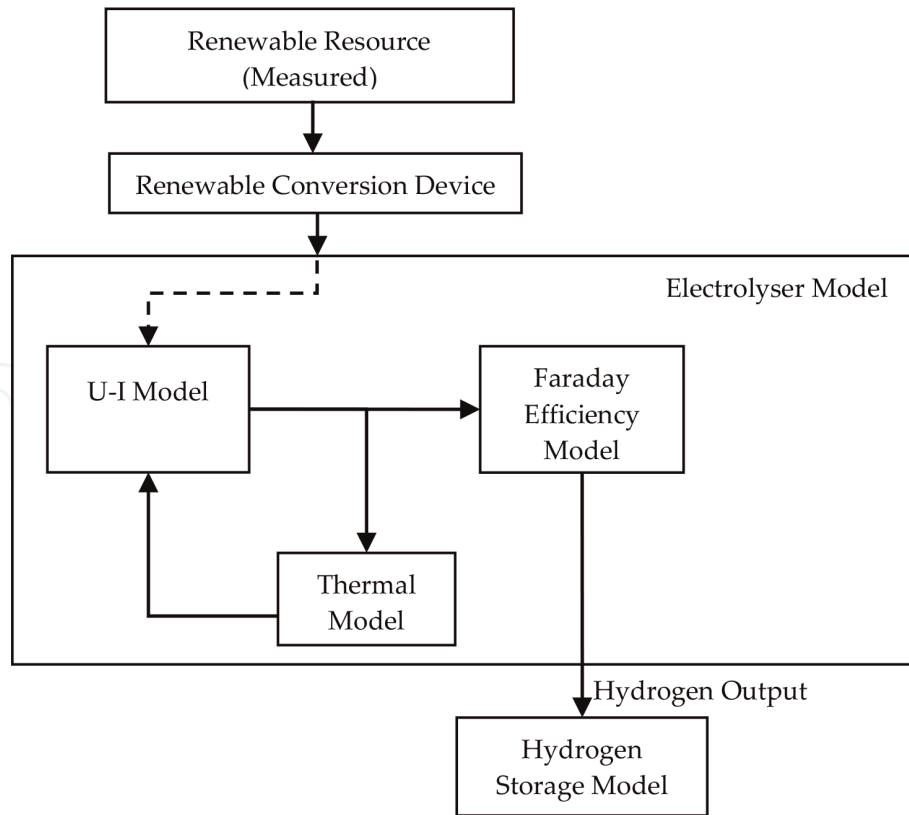
output of thermally compensated model from the hydrogen output of the fixed temperature model of step 2.

## 7.2 Developing the electrolyzer model

A robust electrolyzer model, shown in **Figure 14**, is developed in this section to be used in the proposed algorithm to identify the effects of thermal transients on the overall hydrogen production. To formulate an accurate and robust electrolyzer model that can accurately predict the electrochemical and thermal dynamic behavior of an advanced alkaline electrolyzer, the model is developed based on Øystein Ulleberg model [19] while integrating the voltage/current U-I relationship, the faraday efficiency, as well as the thermal and the pressurized hydrogen storage modeling components.

### 7.2.1 The voltage/current U-I curve

An electrolyzer operating characteristic is determined by its voltage and current profile. The quantity of hydrogen produced by an electrolyzer varies with the amount of current passing through the electrolytic cell stack. The electrolytic cell voltage develops as more current is absorbed by the electrolyzer to increase the gas output flow. This U-I relationship would be a straight line for an ideal electrolyzer; however, it is a nonlinear relationship due to losses occurring in the electrochemistry and cell structure. The relationship is affected by the ohmic resistance of the electrolyte and electrodes as well as the parasitic loss of “stray” electrolysis. The parasitic loss of stray electrolysis is a phenomenon where the electrons flow down the electrolyte fluid channels instead of flowing directly between the electrodes themselves.



**Figure 14.**  
 Incorporating the effect of thermal transients in electrolyzer model.

The voltage ( $U$ ) required to breakdown the water to produce hydrogen can be expressed in terms of ( $U_{rev}$ ). The voltage required to facilitate the electrolytic dissociation of water molecules is temperature dependent and can be expressed as shown in Eq. (15).

$$U = U_{rev} + \frac{(r_1 + r_2 T)}{A} I + s \log \left( \left( \frac{t_1 + \frac{t_2}{T} + \frac{t_3}{T^2}}{A} I \right) + 1 \right) \quad (15)$$

where  $U$  is the water breakdown (or hydrogen production) voltage (V);  $U_{rev}$  is the overvoltage beyond reversible electrochemical cell voltage;  $r_{1,2}$  is the empirical ohmic resistance parameter of electrolyte ( $\Omega m^2$ );  $T$  is the temperature (K);  $t_{1,2,3}$  is the empirical overvoltage parameter of electrode ( $mA^{-1} m^2$ );  $s$  is the overvoltage parameter of electrode (V);  $A$  is the electrode area ( $m^2$ ); and  $I$  is the current (A).

The reversible cell voltage ( $U_{rev}$ ) is calculated using the empirical Nernst equation for electrolysis given by Eq. (16) [20].

$$U_{rev,T(K)} = 1.5184 - 1.5421 \times 10^{-3} T + 9.523 \times 10^{-5} T \ln T + 9.84 \times 10^{-8} T^2 \quad (16)$$

### 7.2.2 The Faraday efficiency

The Faraday efficiency is the ratio between the actual and maximum theoretical hydrogen mass that can be produced by an electrolyzer. Faraday efficiency losses are caused by parasitic current losses within the electrolysis cell stack. The parasitic current loss increases as a percentage of the overall current with the decreasing current densities and increasing temperatures. Therefore, the percentage of parasitic current loss to the total current flow increases with decreasing current densities. An empirical equation for the Faraday efficiency is shown in Eq. (17).

$$\eta_F = \frac{\left(\frac{I}{A}\right)^2}{f_1 + \left(\frac{I}{A}\right)^2 f_2} \quad (17)$$

where  $\eta_F$  is the Faraday efficiency;  $A$  is the electrode area ( $\text{m}^2$ );  $I$  is the current (A);  $f_1$  is the Faraday efficiency parameter  $\text{mA}^2 \text{cm}^{-4}$ ;  $f_2$  is the Faraday efficiency parameter (number between 0 and 1); and  $f_1$  and  $f_2$  are selected empirically.

Faraday's law also models the production rate of hydrogen in an electrolytic cell. The production rate of hydrogen is directly proportional to the transfer rate of electrons at the electrodes. This is equivalent to the electrical current provided by the power supply. Therefore, the total hydrogen production rate in an electrolysis stack consisting of several cells connected in series can be expressed, as shown in Eq. (18).

$$\dot{n}_{\text{H}_2} = \eta_F \frac{n_c I}{zF} \quad (18)$$

where  $\dot{n}_{\text{H}_2}$  is the molar flow rate ( $\text{mol s}^{-1}$ );  $\eta_F$  is the Faraday efficiency;  $z$  is 2 (number of electrons transferred per reaction);  $I$  is the current (A);  $F$  is the Faraday constant  $96,485 \text{ C mol}^{-1}$ ; and  $n_c$  is the number of series cells in electrolyzer cell stack.

### 7.2.3 The thermal model

The production of heat in an electrolyzer is primarily caused by electrical inefficiencies. The energy efficiency can be calculated from the thermo-neutral voltage ( $U_{\text{tn}}$ ) and the cell voltage ( $U$ ) using Eq. (19).

$$\eta_e = \frac{U_{\text{tn}}}{U} \quad (19)$$

where  $\eta_e$  is the energy efficiency;  $U_{\text{tn}}$  is the thermo-neutral voltage  $\cong 1.477 \text{ V}$ ; and  $U$  is the cell voltage.

The value for  $U_{\text{tn}}$  remains almost constant within the pressure and temperature range considered here (0–1200 kPa pressure, 0–80°C temperature), this value is 1.477 V [21].

The operating temperature of an electrolyzer can be found from the overall thermal energy balance of the electrolysis system. The thermal energy balance of the electrolyzer can be expressed, as shown in Eq. (20), where Eq. (21) calculates the thermal energy created by the electrolysis process, and Eq. (22) is used to calculate the thermal losses of the electrolyzer system. Equation (23) is applied to maintain the electrolyzer temperature at or below the maximum temperature specified by manufacturer; it is assumed that electrolyzer cooling system is sufficient to remove the excess heat generated by the electrolysis process.

$$C_t \frac{dT}{dt} = \dot{Q}_{\text{gen}} - \dot{Q}_{\text{loss}} - \dot{Q}_{\text{cool}} \quad (20)$$

$$\dot{Q}_{\text{gen}} = n_c (U - U_{\text{tn}}) I = n_c U I (1 - \eta_e) \quad (21)$$

$$\dot{Q}_{\text{loss}} = \frac{1}{R_t} (T - T_a) \quad (22)$$

$$\dot{Q}_{\text{cool}} > \dot{Q}_{\text{gen}} - \dot{Q}_{\text{loss}} \quad (23)$$

where  $\dot{Q}_{gen}$  is the thermal energy created by electrolysis process;  $\dot{Q}_{loss}$  is the thermal energy lost to the environment;  $\dot{Q}_{cool}$  is the thermal energy dissipated by cooling system;  $C_t$  is the thermal capacity (or inertia) of electrolyzer ( $JK^{-1}$ );  $R_t$  is the thermal resistance of electrolyzer ( $W^{-1}K$ );  $n_c$  is the number of cells in the electrolysis stack;  $\eta_e$  is the energy efficiency (%);  $U_{tn}$  is the thermo-neutral voltage (V);  $U$  is the cell voltage (V);  $T$  is the electrolyzer temperature (K);  $T_a$  is the ambient temperature (K); and  $t$  is the time (seconds).

To calculate the electrolyzer temperature as time passes ( $T$ ), it is assumed that the electrolyzer exhibits a constant heat generation and heat transfer profile for a small-time interval of not more than a few seconds. An intra-time-step steady-state thermal model can be expressed, as shown in Eq. (24), where  $T_{ini}$  is the initial temperature and  $\Delta t$  is the change in time.

$$T = T_{ini} + \frac{\Delta t}{C_t} (\dot{Q}_{gen} - \dot{Q}_{loss} - \dot{Q}_{cool}) \quad (24)$$

#### 7.2.4 Pressurized hydrogen storage modeling

When hydrogen is produced by the electrolyzer, there is a need to store it and therefore there is a need to include hydrogen storage modeling to the proposed model. The two main components needed to model pressurized hydrogen storage is the formula for the pressure considering the gas behavior and the compressibility factor  $Z$ .

The ideal gas relationship can be used to describe the behavior of real hydrogen gas accurately only at relatively low pressures up to approximately 1450 psig and at normal ambient temperatures, results then become increasingly inaccurate at higher pressures. One of the easiest ways to account for this additional compression is through the addition of a compressibility factor, designated by the symbol  $Z$ . The  $Z$  factor is derived from the data obtained through experimentation and it depends on temperature, pressure, and on the nature of the gas. The  $Z$  factor is used as a multiplier to adjust the ideal gas law to fit into the actual gas behavior, as shown in Eq. (25).

$$P = Z\rho RT \quad (25)$$

where  $P$  is the absolute pressure in Pascal;  $\rho$  is the density;  $T$  is the absolute temperature in Kelvin; and  $R$  is the universal gas constant, 8.31434 Nm/mol K.

**Calculating Z:** The National Institute for Standards and Technology has developed a mathematical method for calculating compressibility factors accurately using a virial equation based on pressure (MPa) and temperature (K) [22]. The compressibility factor for hydrogen at different pressures and temperatures can be calculated to a high degree of accuracy by using Eq. (26) and the constants listed in **Table 4** [23, 24].

$$Z(P, T) = \frac{P}{\rho RT} = 1 + \sum_{i=1}^9 a_i \left(\frac{100}{T}\right)^{b_i} \left(\frac{P}{1}\right)^{c_i} \quad (26)$$

where the equation and its constants are defined for pressures in Mega-Pascal (MPa) and temperatures in Kelvin (K).

### 7.3 Developing the electrolyzer model using MATLAB/Simulink

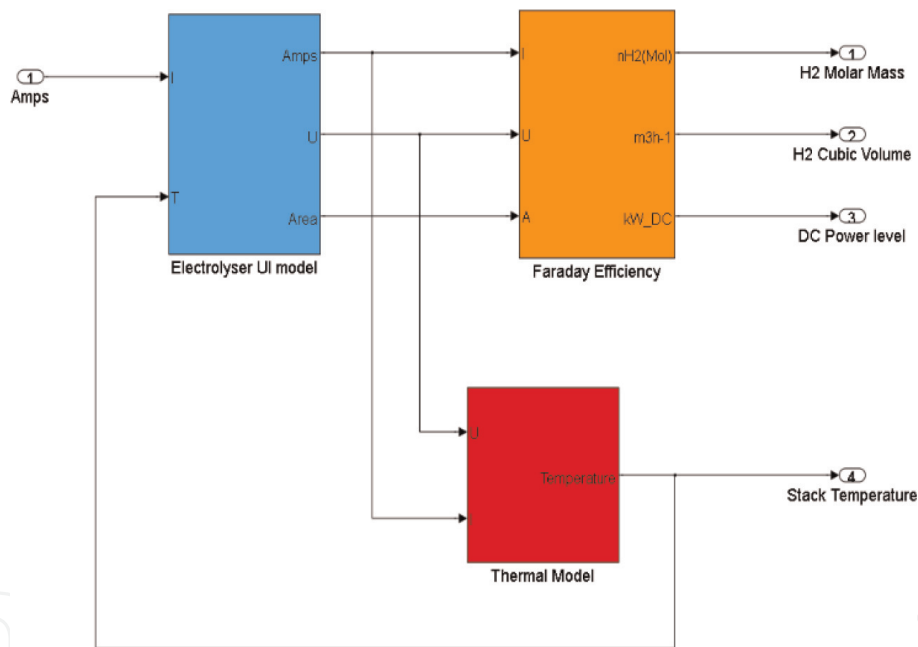
The previously developed modeling equations are used in this section to develop a MATLAB-Simulink model. The developed MATLAB model is then used in a novel way to assess the integrity of operational real-life hydrogen installations.



I	$a_i$	$b_i$	$c_i$
1	0.05888460	1.325	1.0
2	-0.06136111	1.87	1.0
3	-0.002650473	2.5	2.0
4	0.002731125	2.8	2.0
5	0.001802374	2.938	2.42
6	-0.001150707	3.14	2.63
7	$0.9588528 \times 10^{-4}$	3.37	3.0
8	$-0.1109040 \times 10^{-6}$	3.75	4.0
9	$0.1264403 \times 10^{-9}$	4.0	5.0

Molar mass:  $M = 2.01588 \text{ g/mol}$ .  
 Universal Gas Constant:  $R = 8.314472 \text{ J/(mol K)}$ .

**Table 4.**  
 Constants to calculate Z.



**Figure 15.**  
 Interaction between the U-I, the Faraday efficiency and the thermal subsystem models in MATLAB/Simulink.

The hydrogen generation and storage mathematical model, described by Eqs. (15)–(26), is implemented under the Simulink framework to develop the MATLAB Simulink model. **Figure 15** illustrates the interaction between the developed MATLAB Simulink subsystems for the U-I model, the Faraday efficiency model, and the thermal model but without any thermal compensation. The pressurized modeling is not shown in **Figure 15**, but it has been accounted for through the H<sub>2</sub> Molar Mass.

However, the simulation results for this model do not reflect the real hydrogen installations results, and thus the developed model is modified to include a newly added thermal compensation factor which is detailed in the next subsection.

#### 7.4 Developing the thermally compensated electrolyzer model: compensating the temperature effect in an electrolysis system

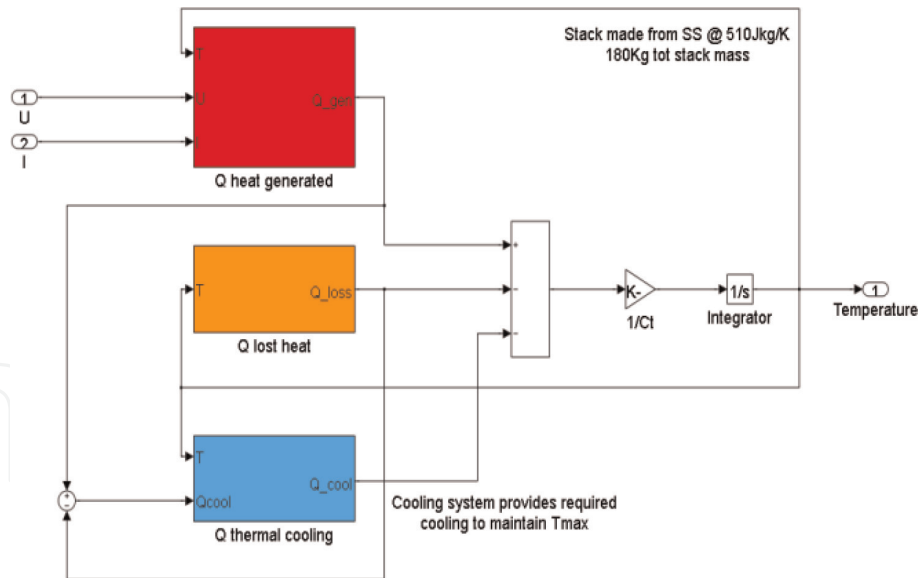
Simulating an electrolyzer without considering the thermal compensation leads to a nonnegligible error in the simulation which can lead to a miscalculation of the return on investment (ROI). This is especially true during a cold start of an electrolyzer. An electrolyzer is said to be in a cold start when it is switched on in any of the following situations: (i) the electrolyzer is cold (not heated up and not at its standard operating temperature), (ii) not under pressure. Note that a standard operating temperature for an alkaline electrolyzer is about 80°C; for a proton exchange membrane (PEM) electrolyzer, it is about 70°C; and for a solid oxide electrolyzer (SOE), this varies with the material being used to construct the cells. In a cold start situation, the electrolyzer is cold and not under pressure and thus its efficiency is low as it requires pressurizing and heating itself up. This takes a short time if the electrolyzer is small; however, this time dramatically increases as the size of the electrolyzer increases. For alkaline electrolyzers, this time may be 1 s for small ones but can take up to several minutes for large ones; however, time is less for the PEM technology. The developed thermally compensated model will therefore be focused on alkaline electrolyzers as they are the ones that suffer the most from heat compensation effect.

To simulate the practical operation of an electrolysis system, it is important to include compensation of the effects of temperature on the electrolytic process. The exothermic thermal reaction that takes place during electrolysis in an alkaline electrolyzer impacts the energy efficiency of the gas generation process and especially the UI relationships. In other words, as hydrogen is being produced by the electrolyzer, an electrochemical reaction takes place at the electrodes. This reaction heats up the electrolyte and the associated electrode materials (this is known as the exothermic reaction) resulting into an increase in temperature which leads to reduction in the cell voltage and cell current needed to generate the hydrogen gas. In other words, the increase in the electrolyzer temperature reduces the power requirements of the electrolytic cells for the same hydrogen production, thereby increasing the system efficiency.

Integrating the thermal model within the previously developed electrolyzer model enables the thermal energy efficiency to be incorporated, and thus allows the model to generate output data that is extremely close to the real-world electrolyzer performance. **Figure 16** depicts the thermally compensated architecture included in the developed Simulink model. The new model considers the thermal energy generated by electrolysis ( $Q_{gen}$ ), the thermal capacity of the electrolyzer itself to absorb and dissipate thermal energy ( $Q_{loss}$ ), and the cooling system to maintain the thermal equilibrium required for an efficient hydrogen generation ( $Q_{cool}$ ) and utilizes Eq. (23) to calculate the thermal balance of the electrolytic process.

#### 7.5 Verification of the developed model

Two case studies are provided in this section to verify the developed model and validate that thermally compensated electrolyzer models are critical not only for designing new hydrogen installations, but also for monitoring the performance of operational ones. These case studies are carried out on two real-world field installed systems. The first one is used to verify that the developed model can accurately simulate hydrogen energy systems. The second is used to verify that the developed model can be used as a tool for investigating the operational integrity of operating electrolyzer systems and checking their performance while identifying any failures to support the reduction in maintenance requirements.



**Figure 16.**  
The thermally compensated model developed under MATLAB/Simulink framework.

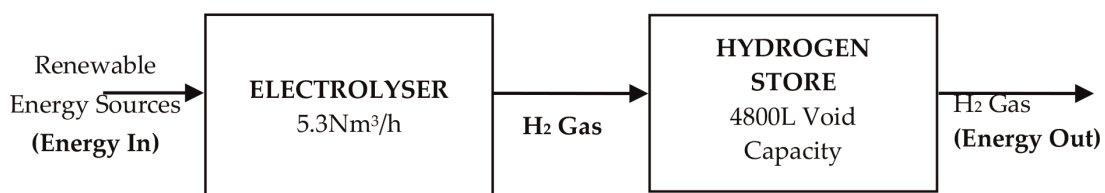
### 7.5.1 Verifying the developed model can accurately simulate hydrogen energy generators

A 30 kW real-world alkaline electrolyzer, which is operational within an existing hydrogen installation, is chosen to verify that the developed electrolyzer Simulink model can accurately simulate it. This 30 kW alkaline electrolyzer can develop 5.3 Nm<sup>3</sup>/h of hydrogen at a pressure up to 1200 kPa. It consists of two electrolytic cell stacks; each stack has 90 cells configured in a series connected array. The electrolyzer is designed to operate at a temperature of 60°C. **Figure 17** shows the electrolyzer (i.e., the hydrogen generator) connected to a 4800 L gas bottle array for the storage of the generated hydrogen at a pressure up to 1200 kPa.

**Table 5** gives the values for the electrolyzer variables, while values for the variables of the modular hydrogen storage system which is connected directly to the electrolysis system are given in **Table 6**.

A data-log of the current consumed by the real-world electrolyzer while in operation is given in **Figure 18**. The electrolyzer temperature and pressure responses to the current are also recorded and compared to the results from the developed Simulink model, as illustrated in **Figures 19** and **20**, respectively. Both figures demonstrate that the developed model results are very close to the data collected from the operating electrolyzer, thus confirming that the developed model can be used for accurately simulating real-world installations.

On further analyzing **Figure 19**, it can be noticed that the electrolyzer is switched on at time 133 s (cold start) and it reaches its operating temperature (and pressure) at time 309 s; thus, the time taken from the cold start to the operating temperature is 176 s. This means that the electrolyzer almost took 3 min to reach its operating conditions and substantial amounts of hydrogen will not be produced



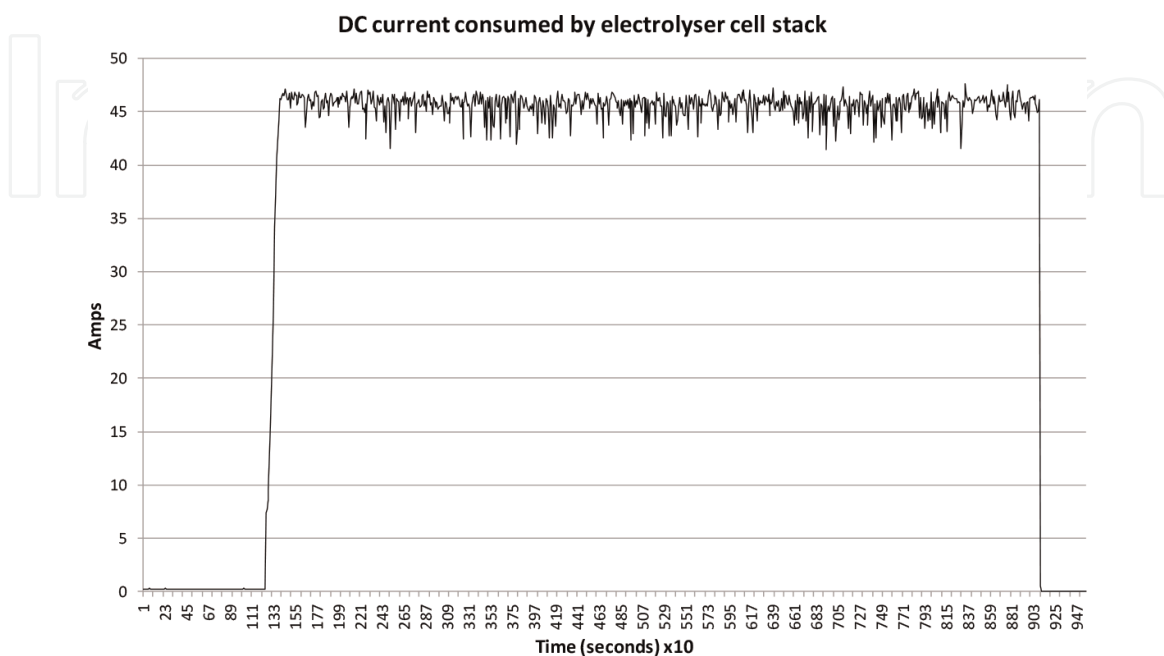
**Figure 17.**  
Hybrid renewable H<sub>2</sub> generation and storage.

Variable	Description	Unit	Value
$r_1$	Electrolyte ohmic resistive parameter	$\Omega\text{m}^2$	0.0000805
$r_2$	Electrolyte ohmic resistive parameter	$\Omega\text{m}^2$	-0.0000025
A	Electrode area	$\text{m}^2$	0.37
S	Overtoltage parameter of electrode	V	0.19
$t_1$	Empirical overtoltage parameter of electrode	$\text{A}^{-1}\text{m}^2$	1.002
$t_2$	Empirical overtoltage parameter of electrode	$\text{A}^{-1}\text{m}^2$	8.424
$t_3$	Empirical overtoltage parameter of electrode	$\text{A}^{-1}\text{m}^2$	247.3
$f_1$	Faraday efficiency parameter	$\text{mA}^2\text{cm}^{-4}$	200
$f_2$	Faraday efficiency parameter	0...1	0.94
$V_{\text{std}}$	Volume of ideal gas at STP	$\text{m}^3\text{mol}^{-1}$	0.0224136
$R_t$	Thermal resistance of electrolyzer	$\text{W}^{-1}\text{K}$	0.018
$C_t$	Thermal capacity of electrolyzer	$\text{JK}^{-1}$	300,000
$n_c$	Number of cells in electrolysis stack	N	180
$T_a$	Ambient temperature	$^{\circ}\text{C}$	20
$T_{\text{max}}$	Maximum operating temperature of electrolyzer	$^{\circ}\text{C}$	60
$T_{\text{hyst}}$	Cooling hysteresis thermal band	$^{\circ}\text{C}$	3

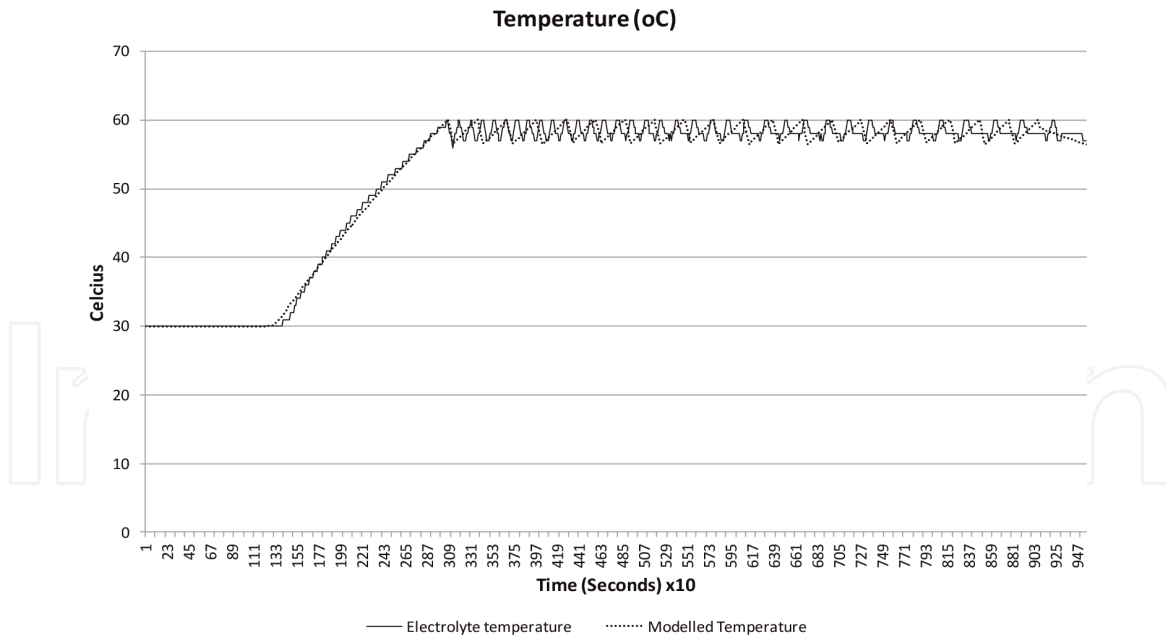
**Table 5.**  
 Electrolyzer variables—variables for the 30 kW alkaline electrolyzer.

Variable	Description	Unit	Value
V	Tank volume	$\text{m}^3$	4.8
$T_a$	Ambient temperature	$^{\circ}\text{C}$	20

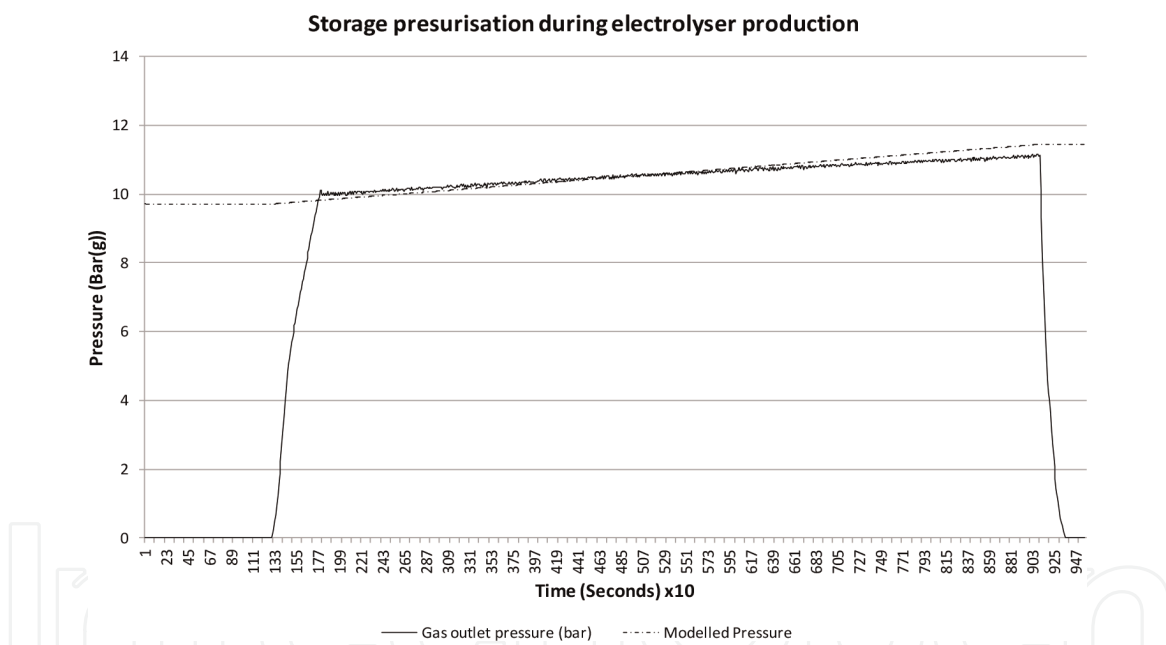
**Table 6.**  
 Variables for the hydrogen storage—4800 L void capacity.



**Figure 18.**  
 Data-log of the current consumed by 30-kW electrolyzer while in operation.



**Figure 19.**  
Recorded electrolyzer temperature versus model output.



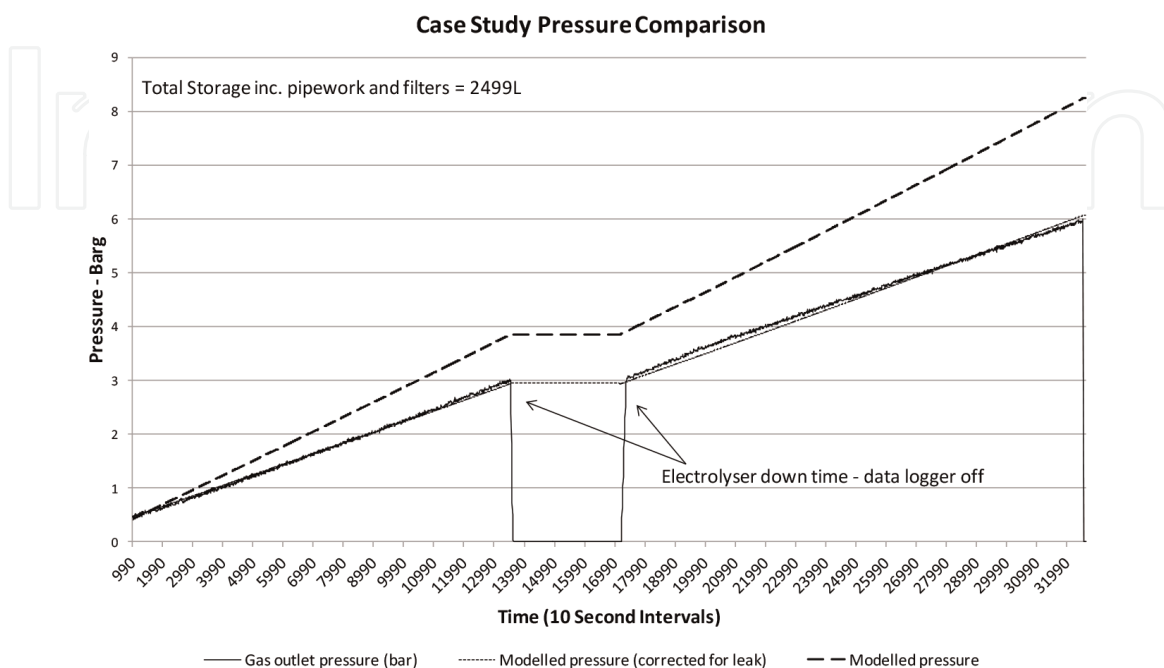
**Figure 20.**  
Recorded electrolyzer pressure versus model output.

during this time. If such a small electrolyzer took 3 min to reach its steady-state operation, then it can be tangibly assumed that this time will be much higher for a larger scale electrolyzer and substantial loss in hydrogen production could be realized. Considering the financials, it will be consequently affected by the loss in the hydrogen production during the cold start period. It can therefore be concluded that the inaccurate hydrogen production numbers generated from nonthermally compensated hydrogen generators simulation models will generate misleading higher ROI values. Thus, it can be also concluded that the developed thermally compensated simulation model is essential for accurately calculating the potential for financial return of a hydrogen system since it allows the accurate computation of hydrogen production.

### 7.5.2 Verifying that the developed model can be used as a tool for identifying performance issues within operational hydrogen systems

The thermally compensated electrolyzer model is further tested in one of the most unexploited applications for any model—its use in a postinstallation scenario. When an electrolyzer model is developed, it is usually used in the preinstallation stage to investigate if the planned system will operate as anticipated when installed in the field. In this section, the developed model is further used in a postinstallation scenario to demonstrate that it is also capable to detect issues within operating systems removing the need for maintenance crew on-site inspection.

The developed Simulink model was used to simulate an operating hydrogen generator when its performance was detected to be not as anticipated for a couple of weeks. It was suspected that the electrolyzer has developed an internal issue, so the aim was to examine if the developed model can be used in a post-installation situation to determine this performance issue. The operating hydrogen system, on which the developed Simulink model was tested in a postinstallation scenario, is been operating in Africa for over 8 years and it employs a 30 kW alkaline electrolyzer identical to that given in **Table 5** connected to a storage system of 2499 L void volume capacity. On comparing the model output results to the on-site collected data, two performance issues were doubted. The first was an early degradation of the stack; however, this was disregarded as none of the other similar installed stacks illustrated such a drastic performance issue. The second was the presence of a hydrogen leak; and this was clear from the divergence between the modeled and recorded data shown in **Figure 21**. The figure shows that there was more H<sub>2</sub> production in the model results than what was achieved in the practical installation, and this in turn suggests a leak within the installed system. This suggestion was confirmed by an on-site inspection of the hydrogen system which revealed that a fitting in the pipe that carries the H<sub>2</sub> gas from the electrolyzer to the storage system had developed a premature failure. The fast rate of detected leak spray bubbling, shown in **Figure 21**, indicates the presence of a leak on two sides of the faulty pipe fitting shown in **Figure 22**. This finding clearly demonstrates the apparent benefit of the developed model in identifying leakages during operation,



**Figure 21.**  
*Divergence between the modeled and recorded pressures indicating a suspected hydrogen gas leak.*



**Figure 22.**  
*Source of leakage identified after on-site inspection.*

and thus it can save the time and cost of maintenance inspection as well as preventing the safety hazards associated with the hydrogen vented in atmosphere.

The developed thermally compensated model has been able to reveal this hydrogen gas leak, which was about 10.89 g, equating to a 2.3% reduction in the overall system efficiency. This leak was so small for the leak detection system to detect; therefore, if many small leaks like this occur at different locations of a large-scale system without being detected by the safety alarm system this could lead to more financial losses and potentially a hazardous situation. Therefore, the developed model can be used as a tool to provide an early warning of leakages or other issues, and thus provided an extra layer of safety and a potential for increasing the financial return through the development of a predictive maintenance system.

## 8. Conclusion

In conclusion, the contributions to knowledge that has been presented within this chapter can be summarized as follows:

- A novel levelized cost model has been developed for investigating the financial competitiveness of the hydrogen energy storage technology. It has been identified that hydrogen use as an energy storage mechanism achieves the most financial competitiveness when the by-product oxygen is utilized.
- A new deterministic sizing methodology that offers a rapid initial sizing of renewable hydrogen energy storage systems has been given. The proposed method requires a very limited number of input data to offer an initial system size for a hybrid renewable hydrogen energy storage system (HRHES) very quickly, and thus it is useful at the very early initial design phase to assist in the early decision-making for system implementation. To develop this sizing model, a model has been developed for every single item in the proposed HRHES (the implemented renewable energy sources, the electrolyzer, H<sub>2</sub> storage, and fuel cell). These models were then integrated together.

- An algorithm for modeling the impact of thermal transients, especially in alkaline electrolyzers, on the overall hydrogen production has been developed. The prolonged thermal transients, associated with electrolyzers fed by renewable energy sources, result into extended periods of time where the electrolyzer does not produce hydrogen at its highest efficiency, and thus resulting into an overall reduction in its hydrogen production. The typical effect of thermal transients on the electrolyzer hydrogen production can be found by using the proposed algorithm, and a reduction in the cumulative hydrogen production was found to be in the range between 1 and 3%.
- The thermally compensated electrolyzer model has been developed in Simulink and has proven, through a case study, to be able to accurately simulate hydrogen generation and storage systems. The developed model presents a key finding for the hydrogen industry as it does not only allow the investigation of hydrogen systems performance in a preinstallation scenario prior to embarking into the expensive capital investment, but also proven to be useful in postinstallation scenarios. The developed model was found to be able to simulate operational installed hydrogen systems and assist in identifying their performance issues accurately.

IntechOpen

### Author details


Dallia Mahmoud Morsi Ali

Robert Gordon University, Aberdeen, Scotland, United Kingdom

\*Address all correspondence to: [dolly.ali@hotmail.co.uk](mailto:dolly.ali@hotmail.co.uk); [d.ali@rgu.ac.uk](mailto:d.ali@rgu.ac.uk)

### IntechOpen

---

© 2019 The Author(s). Licensee IntechOpen. This chapter is distributed under the terms of the Creative Commons Attribution License (<http://creativecommons.org/licenses/by/3.0>), which permits unrestricted use, distribution, and reproduction in any medium, provided the original work is properly cited. 



## References

- [1] Hydrogen Council Vision. How Hydrogen Empowers the Energy Transition. 2017. Available from: <http://hydrogencouncil.com/wp-content/uploads/2017/06/Hydrogen-Council-Vision-Document.pdf>
- [2] Stern LN. The Economics of Climate Change: The Stern Review. Cambridge: Cambridge University Press; 2006
- [3] The Importance of Flexible Electricity Supply. United States Department of Energy, Solar Technologies Programme, Solar Integration Series 1 of 3, DOE/GO-102011-3201; 2011
- [4] Wilson IAG, McGregor PG, Infield DG, Peter J. Grid-connected renewables, storage and the UK electricity market. Hall, Elsevier Renewable Energy. 2011;**36**: 2166-2170
- [5] Nelson DB, Nehrir MH, Wang C. Unit sizing and cost analysis of stand-alone hybrid wind/PV/fuel cell power generation systems. Elsevier Renewable Energy Journal. 2005;**31**
- [6] Loisel R. Power system flexibility with electricity storage technologies: A technical-economic assessment of a large-scale storage facility. Electrical Power and Energy Systems. 2012;**42**: 542-552. DOI: 10.1016/j.ijepes.2012.04.058
- [7] Orecchini F, Santiangeli A. Beyond smart grids - the need of intelligent energy networks for a higher global efficiency through energy vectors integration. International Journal of Hydrogen Energy. 2011
- [8] Wade NS, Taylor PC, Lang PD, Jones PR. Evaluating the benefits of an electrical energy storage system in a future smart grid. Journal of Energy Policy. 2010
- [9] McDowall J. Integrating energy storage with wind power in weak electricity grids. Journal of Power Sources. 2006;**162**:959-964
- [10] Edberg O, Naish C, McNaught C. Energy Storage and Management Study. AEA Technology for the Scottish Government, ELL/000/077, revision 4; 2010
- [11] Luickx PJ, Delarue ED, D'haeseleer WD. Considerations on the backup of wind power: Operational backup. Journal of Applied Energy. 2008
- [12] Coll-Mayor D, Paget M, Lightner E. Future intelligent power grids: Analysis of the vision in the European Union and the United States. Elsevier Energy Policy Journal. 2006
- [13] Constable J, Moroney L. High Rewards for Wind Farms Discarding Electricity 5-6th April 2011, Renewable Energy Foundation Information Note; 2011
- [14] U.S. Energy Information Administration Office of Integrated Analysis and Forecasting. International Energy Outlook 2010. DOE/EIA-0484 (2010); 2010
- [15] Daima TU, Li X, Kim J, Simms S. Evaluation of energy storage technologies for integration with renewable electricity: Quantifying expert opinions. Elsevier Environmental Innovation and Societal Transitions. 2012;**3**:29-49
- [16] Beaudin M, Zareipour H, Schellenberglabe A, Rosehart W. Energy storage for mitigating the variability of renewable electricity sources: An updated review. Elsevier Energy for Sustainable Development. 2010;**14**: 302-314
- [17] Gazey R, Ali D, Aklil D. Techno-economic assessment of hydrogen

- energy storage systems for Enabling the projected increase of renewables onto electrical power grids. In: Proceeding of the IET Renewable Power Generation Conference RPG. Edinburgh, UK; 2011. Available from: <http://conferences.theiet.org/rpg/index.cfm>
- [18] IEA Agreement on the Production and Utilization of Hydrogen. IEA-HIA Task 18 Sub-Task B Final Report; 2007. ISBN 978-0-9815041-0-0
- [19] Gray D. Smart Grids and Virtual Power Plants: Point of Departure. Robert Gordon University; 2011
- [20] Tessengerlo Group. Annual Report; 2003
- [21] Maisonnier G, Perrin J, Steinberger-Wilckens R. Industrial surplus hydrogen and markets and production, deliverable 2.1 and 2.1a, Roads2HyCom, Document Number: R2H2006PU.1; 2007
- [22] Crockett RGM, Newborough M, Highgate DJ. Electrolyser based energy management: A means for optimizing the exploitation of variable renewable energy resources in standalone applications. *Solar Energy Journal*. 1997; **61**(5):293-302
- [23] Aklil TD, Goodhand R, Eguizábal MG. The h2seed Project. M. San Antonio Fuel Cell Seminar & Exposition; 2007
- [24] Stoyel J. Hydrogen Mini Grid System: An Iconic Development for Yorkshire Forward
- [25] Kraemer M. Renewable energy storage and hydrogen energy. In: Presentation to Grove Fuel Cell Symposium, London; 2009
- [26] Ulleberg Ø, Nakken T, Eté A. The wind/hydrogen demonstration system at Utsira in Norway: Evaluation of system performance using operational data and updated hydrogen energy system modelling tools. *International Journal of Hydrogen Energy*. 2010; **35**(2010):1841-1852
- [27] Hydrogen office opens in Scotland. *Fuel Cells Bulletin*. 2011; **2011**(2):9-10. DOI: 10.1016/S1464-2859(11)70092-X
- [28] Yilanci A, Dincer I, Ozturk HK. A review on solar-hydrogen/fuel cell hybrid energy systems for stationary applications. *Elsevier Progress in Energy and Combustion Science*. 2009; **35**:231-244
- [29] Gahleitner G. Hydrogen from renewable electricity: An international review of power-to-gas pilot plants for stationary applications. *International Journal of Hydrogen Energy*. 2013; **38**: 2039-2061
- [30] Stiller C, Stubinitzky A. Hydrogen for grid scale storage of renewable energy. In: World Hydrogen Energy Conference. 2012
- [31] Water electrolysis and renewable energy systems. *Fuel Cell Today*. 2013
- [32] Forsberga P, Karlström M. On optimal investment strategies for a hydrogen refueling station. *International Journal of Hydrogen Energy*. 2007; **32**:647-660
- [33] Aklil-D'Halluin D, Johnson E, Gazey R, et al. Remote Communities & Islands—An Economical Case for Hydrogen Technologies. UNIDO; 2008
- [34] Ali D. Energy capacity and economic viability assessment of the renewable hydrogen energy storage as a balancing mechanism in addressing the electric system integration issues inherent with variable renewable energy resources. In: Proceeding of the IET Reliability of Transmission Distribution Networks Conference RTDN. London, UK: Dexter House; 2011. Available from: [www.theiet.org/rtdn](http://www.theiet.org/rtdn). <http://www.bjadks.com/iet.tv/detail/2751.html>

- [35] Díaz-González F, Sumper A, Gomis-Bellmunt O, Villafáfila-Robles R. A review of energy storage technologies for wind power applications. *Elsevier Renewable and Sustainable Energy Reviews*. 2012;**16**:2154-2171
- [36] Zheng J, Liu X, Xu P, Liu P, Zhao Y, Yang J. Development of high pressure gaseous hydrogen storage technologies. *International Journal of Hydrogen Energy*. 2012;**37**:1048-1057
- [37] Chen H, Cong TN, Yang W, Tan C, Li Y, Ding Y. Progress in electrical energy storage system: A critical review. *Progress in Natural Science*. 2009;**19**: 291-312
- [38] Ferreira HL, Garde R, Fulli G, Kling W, Lopes JP. Characterisation of electrical energy storage technologies. *Energy*. 2013;**53**:288-298
- [39] Ibrahima H, Ilincaa A, Perron J. Energy storage systems characteristics and comparisons. *Renewable and Sustainable Energy Reviews*. 2008;**12**: 1221-1250
- [40] Electric Energy Storage Technology Options: A White Paper Primer on Applications, Costs and Benefits. Palo Alto, CA: Electric Power Research Institute (EPRI); 2010. p. 1020676
- [41] MacDonald M. UK Electricity Generation Costs Update. Department of Energy & Climate Change; 2010
- [42] Akhil AA, Huff G, Currier AB, Kaun BC, Rastler DM, Chen SB, et al. DOE/EPRI 2013 Electricity Storage Handbook in Collaboration with NRECA. Sandia National Laboratories, SAND2013-5131; 2013
- [43] Harrison K. Analysis of hydrogen and competing Technologies for Utility-Scale Energy Storage. In: IPHE Workshop. Spain; 2012
- [44] Sundararagavan S, Baker E. Evaluating energy storage technologies for wind power integration. *Solar Energy*. 2012;**86**:2707-2717
- [45] Steward D, Saur G, Penev M, Ramsden T. Ramsden. Cost Analysis Highlights Hydrogen's Potential for Electrical Energy Storage. Technical Report NREL/TP-560-46719; 2009
- [46] Erdinc O, Uzunoglu M. Optimum design of hybrid renewable energy systems: Overview of different approaches. *Renewable and Sustainable Energy Reviews*. 2012;**16**:1412-1425
- [47] Connolly D, Lund H, Mathiesen BV, Leahy M. A review of computer tools for analysing the integration of renewable energy into various energy systems. *Applied Energy*. 2010;**87**:1059-1082
- [48] Castaneda M, Fernandez LM, Sanchez H, Cano A, Jurado F. Sizing methods for stand-alone hybrid systems based on renewable energies and hydrogen. In: Electro-Technical Conference (MELECON), 2012 16th IEEE Mediterranean. DOI: 10.1109/MELCON.2012.6196558
- [49] Watson SJ, Ter-Gazarian AG. The optimization of renewable energy sources in an electrical power system by use of simulation and deterministic planning models. *International Transactions in Operational Research*. 1996;**3**(3/4)
- [50] Wang C, Nehrir MH. Power management of a stand-alone wind/ photovoltaic/fuel cell energy system. *IEEE Transactions on Energy Conversion*. 2008;**23**(3)
- [51] Ulleberg Ø. Stand-alone power systems for the future: Optimal design, operation & control of solar-hydrogen energy systems. [Ph.D. dissertation]. Trondheim, Norway: Norwegian Univ. Sci. Technol.; 1998

[52] Gazey RN. Design and development of an integrated prototype renewable hydrogen energy system. [MPhil Thesis]. Robert Gordon University; 2006

[53] Ali D, Gazey R. Developing a thermally compensated electrolyser model coupled with pressurized hydrogen storage for modelling the energy efficiency of hydrogen energy storage systems and identifying their operation performance issues. *Renewable & Sustainable Energy Reviews Journal*. 2016;**66**:27-37

IntechOpen