



**ROBERT GORDON
UNIVERSITY • ABERDEEN**

OpenAIR@RGU

The Open Access Institutional Repository at Robert Gordon University

<http://openair.rgu.ac.uk>

This is an author produced version of a paper published in

Building and Environment (ISSN 0360-1323)

This version may not include final proof corrections and does not include published layout or pagination.

Citation Details

Citation for the version of the work held in 'OpenAIR@RGU':

TAYLOR, B. J. and IMBABI, M. S., 1997. The effect of air film thermal resistance on the behaviour of dynamic insulation. Available from *OpenAIR@RGU*. [online]. Available from: <http://openair.rgu.ac.uk>

Citation for the publisher's version:

TAYLOR, B. J. and IMBABI, M. S., 1997. The effect of air film thermal resistance on the behaviour of dynamic insulation. *Building and Environment* 32(5), pp. 397-404.

Copyright

Items in 'OpenAIR@RGU', Robert Gordon University Open Access Institutional Repository, are protected by copyright and intellectual property law. If you believe that any material held in 'OpenAIR@RGU' infringes copyright, please contact openair-help@rgu.ac.uk with details. The item will be removed from the repository while the claim is investigated.

The Effect of Air Film Thermal Resistance on the Behaviour of Dynamic Insulation

B. J. Taylor^{*}, M. S. Imbabi[•]

Summary

This paper extends the authors' previous analysis of dynamic insulation to include the inner and outer air film resistances with the objective of modelling the variation in surface temperature with air flow. The boundary condition that comes closest to predicting the variation of the surface temperature with air flow is to assume that the conduction heat flux at the wall surface, rather than the net heat flux, is equal to the flux incident on the wall from global environmental temperature T_{ej} . Comparison of predictions of the temperature drop across the inner and outer air films with data from a hot box experiment show that the theory predicts the decreasing surface temperatures with increasing air flow. However, further experimental work is required to confirm the magnitude of the changes.

Notation

A length parameter, relative measure of convective and conductive heat fluxes (m^{-1})

c_a specific heat of air ($J/kg \cdot ^\circ C$)

^{*} The Scott Sutherland School of Architecture, The Robert Gordon University, Aberdeen, AB9 2QB, UK

[•] The Department of Engineering, Kings College, The University of Aberdeen, Aberdeen, AB9 2UE, UK

G dimensionless parameter, a measure of the total thermal resistance of the envelope

L distance between outer and inner surfaces (m)

q total heat flux (W/m^2)

q_{c0} conduction heat flux at outer surface (W/m^2)

q_c conduction heat flux (W/m^2)

q_u convective or bulk flow heat flux (W/m^2)

R total thermal resistance of building element with air flow ($m^2.K/W$)

R_a thermal resistance of outer air film ($m^2.K/W$)

R_i thermal resistance of inner air film ($m^2.K/W$)

R_s total thermal resistance of building element with no air flow ($m^2.K/W$)

T temperature of the air at a point within the envelope ($^{\circ}C$)

T_a temperature of the ambient air ($^{\circ}C$)

T_{ai} temperature of the indoor air ($^{\circ}C$)

T_{ei} global environmental temperature ($^{\circ}C$)

T_o temperature of the outer surface of the external wall ($^{\circ}C$)

T_L temperature of the inner surface of the external wall ($^{\circ}C$)

T_m mean surface temperature of all internal surfaces ($^{\circ}C$)

T_s temperature of the internal surfaces ($^{\circ}C$)

x distance through building element from outer surface (m)

u air velocity (m/s)

λ thermal conductivity ($W/m.^{\circ}C$)

ρ_a density of air (kg/m^3)

1. Introduction

In a previous paper [1] the authors presented an analytical study of dynamic and diffusive insulation for multi-layer, porous envelopes which clarified the mechanisms of heat and mass transfer through the envelope. Dynamic insulation, as it is referred to in Scandinavia and Canada [2], turns on its head the conventional building practice in the UK and other countries of trying to prevent air flowing through walls. By deliberately designing the wall to be porous and by ensuring that the building is always slightly depressurised then the conductive heat loss through the building fabric can be considerably reduced. Other benefits include the control of water vapour transport through the wall without using a vapour barrier and improved indoor air quality.

The authors' previous paper achieved a major simplification by showing that the net heat and mass fluxes depended only on the total thermal and diffusion resistances respectively of the wall and the air flow. Two porous walls composed of materials differing in their individual thermal resistances but having the same total resistance would show the same variation in heat transfer coefficient with air flow rate. The authors' analysis assumed that the inner and outer surface temperatures of the envelope were at constant temperature. This assumption is a good approximation for low air flows or in cases where there are heat sources within the room that will maintain the wall surface temperature constant. However, dynamic insulation is most effective in buildings which require high air change rates such as swimming pools and sports halls so that it is necessary to be able to predict how the wall internal surface temperature will vary with air flow rate through the wall.

Measurements on test walls [3] and in a hot box [4] indicate that, with the air flowing through a porous wall from outside to in, the inner wall surface temperature, and to a lesser extent the outer wall surface temperature, both decrease with increasing air flow. This phenomena whilst previously acknowledged in the literature has not been included in mathematical models of dynamic insulation. Bartussek [5] did include the resistance of the air film on the inner surface but his resulting equations, as will be shown, do not represent the appropriate behaviour at high air flows. Also, in his extensive thesis he did not report any experiments to determine how the wall surface temperature varied with air flow, nor did he explore the consequences for wall surface temperature implied by his theoretical analysis.

The wall surface temperature is a determining factor in determining human comfort. Surveys indicate that for various building types in different climates that during occupation the radiant temperature exceeds the air temperature by 0 to 2°C [6]. However, there are exceptions. In a conventional envelope, impermeable to air, the air temperature may greatly exceed the mean radiant temperature during cold weather in poorly insulated rooms with warm air heating. Dynamically insulated walls will always have internal surface temperatures lower than the room air temperature and this surface temperature will decrease as the air flow increases. As a step towards understanding how a dynamically insulated envelope will integrate with the building heating system and the occupants it is necessary to develop a

theoretical understanding of how the internal surface temperature varies with the air flow through it.

In conventional buildings, the pragmatic approach to the design of heating systems is to define a notional internal environmental air temperature, T_{ei} , which can be estimated from the following weighted average of the mean wall surface temperature, T_m and the indoor air temperature T_{ai} [6]

$$T_{ei} = \frac{2}{3}T_m + \frac{1}{3}T_{ai} \quad 1$$

One of the contributors to this weighting is the radiant heat transfer coefficient which, at $5.7 \text{ W/m}^2\text{K}$, is almost twice that of the convection heat transfer coefficient ($3.0 \text{ W/m}^2\text{K}$). The mean surface temperature T_m is approximated by

$$T_m = \frac{5}{6}T_s + \frac{1}{6}T_L \quad 2$$

where T_L is the surface temperature of an external wall and the remaining five internal surfaces are assumed to be at temperature T_s . Davies [7] gives a good explanation and critique of the concept of environmental temperature. Overall the weighting of the three temperatures that help define a global environmental temperature is given by

$$T_{ei} = \frac{5}{9}T_s + \frac{3}{9}T_{ai} + \frac{1}{9}T_L \quad 3$$

The surface temperature of an external wall makes a small but not insignificant impact on the global environmental temperature. These weightings will change for a room with more than one external wall. Close to a wall the surface temperature will have an increasing impact on human comfort and on condensation risks. Furthermore, air entering the room

through this wall will also be at the surface temperature. Therefore heat will be required to warm this air up to the room air temperature T_{aj} . This paper extends our previous analysis with the objective of modelling the variation in surface temperature with air flow since it is clearly an important consideration in the design of buildings using dynamic insulation.

2. Heat Transfer through a Dynamic Building Element with Inner Air Film

As mentioned the authors' previous paper showed that a multi-layer envelope could, for the purposes of calculating the heat loss, be treated as being equivalent to a single layer with the same total thermal resistance. Since in this paper we are interested in the behaviour of the wall surface temperatures we shall present the theory in terms of a single layer of material without loss of generality. The thermal resistances of the air films adjacent to the envelope will be assumed to be constant and independent of air flow through the wall. The speed of the air as it issues from a porous wall in practical dynamic insulation applications is typically in the region of 0.5 to 5 m/hr. This speed should not significantly affect the convection heat transfer coefficient of the wall surface since it is two orders of magnitude smaller than the CIBSE limit of 0.1 m/s for the air speeds at the wall surface beyond which its recommended values of convective heat transfer coefficients would not be valid. Measurements with a hot wire anemometer indicate that air speeds in the centre of a moderately sealed room heated by a radiator under the window are typically 0.05 to 0.1 m/s. Furthermore, the air speed will have no

impact on the radiant heat transfer coefficient which is the more dominant of the two.

With reference to Figure 1 the governing equation for steady state heat transfer in one dimension is :

$$\frac{d^2T(x)}{dx^2} - A \frac{dT(x)}{dx} = 0 \quad 4$$

where A is defined as

$$A = \frac{u\rho_a c_a}{\lambda} \quad 5$$

The air flow u is taken to be positive in the direction of increasing x . For the case where the wall surface temperatures are constant the solution to equation (4) is:

$$\frac{T(x) - T_0}{T_L - T_0} = \frac{\exp(Ax) - 1}{\exp(AL) - 1} \quad 6$$

If the wall surface temperatures are allowed to vary then the boundary conditions to be applied need a little consideration. On the cold side at $x = 0$, the temperature is T_0 and the heat flux is given by

$$q_{co} = -\frac{T_0 - T_a}{R_a} = -\lambda \left. \frac{dT}{dx} \right|_{x=0} \quad 7$$

where q_{co} is the conductive heat flux at $x = 0$. Since the convective flux is zero at this point q_{co} is also the total heat flux. At the inner surface similar conditions will apply which will result in four equations for the two unknown constants in the general solution of equation (4). Two of these boundary conditions are therefore redundant. Once the particular solution is obtained (see section 3), T_0 and q_{co} are both readily calculated, and therefore attention

will be focused on the conditions at the warm side, where it is not immediately obvious which of the three heat fluxes, conduction, convection or the resultant of the two, is the appropriate one to use.

Consider the volume element enclosing a thin layer in the wall, Δx , and bounded on one side by the wall surface at temperature T_L , as shown in Figure 2. The heat flux into the wall at temperature T_L comprising both convection and radiation is described by the film resistance R_i as

$$q_i = \frac{T_{ei} - T_L}{R_i} \quad 8$$

If it is assumed that the heat flux q_i incident on the wall at temperature T_L is equal to the net flux q which is constant through the wall and decreases with increasing air flow [5] then as the air flow increases q_i will tend to zero and T_L will tend to T_{ei} which is contrary to experimental observation. Whereas if q_i is set equal to the conduction flux q_c , then q_i increases with increasing airflow thus driving down the wall surface temperature. For these reasons it is postulated that the appropriate boundary condition is to set the incident heat flux equal to the conduction flux.

$$q_c = -\frac{T_{ei} - T_L}{R_i} = -\lambda \left. \frac{dT}{dx} \right|_{x=L} \quad 9$$

As shown in Figure 2 the air leaves the wall at temperature T_L and additional heat must be supplied to raise the temperature of the air to T_{ai} .

Solving equation (4) for the boundary conditions $T = T_0$ at $x = 0$ and using equation (9) gives

$$\frac{T(x) - T_0}{T_{ei} - T_0} = \frac{\exp(Ax) - 1}{\lambda AR_i \exp(AL) + \exp(AL) - 1} \quad 10$$

The solution based on Bartussek's assumption is similar but has different properties at high air flows:

$$\frac{T(x) - T_0}{T_{ei} - T_0} = \frac{\exp(Ax) - 1}{\lambda AR_i + \exp(AL) - 1} \quad 11$$

Figure 3 shows how the wall surface temperature varies with air flow for equations (10) and (11). This clearly shows that the assumption that the incident heat flux q_i is equal to the net heat flux leads to physically impossible conclusions, namely that the inner surface temperature tends to the outer surface temperature at zero air flow, that for air flowing out through the wall the inner surface actually becomes colder than the outer surface, and that at high air flows the inner surface temperature tends to the global environmental temperature, all of which are contrary to experience. The assumption that q_i is proportional to the conductive heat flux at the wall surface leads to a more realistic variation in wall surface temperature and so for the rest of this paper will be taken as the working hypothesis. When interested in the surface temperatures, a more compact form of equation (10) is desirable

$$\frac{T_L - T_0}{T_{ei} - T_0} = \frac{R}{R_i G + R} \quad 12$$

where the resistance of the dynamic element R , is defined as

$$R = \frac{T_L - T_0}{q} \quad 13$$

This can be expressed in terms of the resistance without air flow R_s ,

$$R = \frac{T_L - T_0}{q_{c0}} = R_s \frac{G - 1}{\ln(G)} \quad 14$$

where dimensionless parameter G is

$$G = \exp(u\rho_a c_a R_s) \quad 15$$

At zero air flow equation reduces as expected to

$$\frac{T_L - T_o}{T_{ei} - T_o} = \frac{R_s}{R_i + R_s} \quad 16$$

3. Heat Transfer through a Dynamic Building Element with Inner and Outer Air Films

Having established a plausible boundary condition at the inner surface, attention will now be turned to considering the air film at the outer surface. The particular solution to the governing equation (4) was uniquely solved by assuming that the temperature of the outer surface was given, so that inclusion of the outer air film becomes a simple matter of adding thermal resistances, as depicted in Figure 1. A more rigorous analysis would be to use the temperature profile derived above to evaluate the heat flux at the outer surface and equate this to the heat flow through the air film (equation 7). There is no ambiguity here about which heat flux to use since the net heat flux and the conductive heat flux are equal [1].

Differentiating equation (10) and using the boundary condition (equation 7) yields

$$\frac{T_0 - T_a}{T_{ei} - T_0} = \frac{\frac{R_a}{R_s} \ln(G)}{\frac{R_i}{R_s} G \ln(G) + G - 1} = \frac{R_a}{R_i G + R} \quad 17$$

Solving for T_0

$$T_0 = PT_a + QT_{ei} \quad 18$$

where

$$P = \frac{R_i G + R}{R_i G + R + R_a} \quad 19$$

$$Q = \frac{R_a}{R_i G + R + R_a} \quad 20$$

These forms are useful because in the limit of zero air flow, $G = 1$ and $R = R_s$ and the equations readily reduce to the conventional form for three resistances in series. Thus, given T_a , T_{ei} and the air flow rate, the temperature profile through the wall, including both surface temperatures, is now determined.

The heat flux from the wall is found by substituting equation (17) into equation (7),

$$q = \frac{T_{ei} - T_0}{R_i G + R} \quad 21$$

where R is given by equation (14). Without air flow the heat loss per unit area is simply

$$q_s = \frac{T_{ei} - T_0}{R_i + R_s} \quad 22$$

Eliminating the temperature difference between these equations then gives the very useful relationship between the heat loss for dynamic insulation with air flow to that without air flow.

$$\frac{q}{q_s} = \frac{R_i + R_s}{R_i G + R} \quad 23$$

Figure 4 shows that the effect of the inner film resistance is insignificant for both well and poorly insulated walls. This means that when assessing the

relative change in the heat loss of dynamic insulation over the static equivalent the effect of the inner air film can safely be neglected. The outer air film having a smaller resistance than the inner can also be neglected. When considering the surface temperatures, however, the air films cannot, in general, be neglected as shown in the following section.

4. Variation of Wall Surface Temperatures with Air Flow and Thermal Resistance

It is of interest to explore what the above equations imply for the temperature differences across the inner and outer air films in buildings using dynamic insulation. Taking the thermal resistances of an internal vertical surface as $0.123 \text{ m}^2\text{K/W}$ and an outside vertical surface of normal exposure as $0.06 \text{ m}^2\text{K/W}$ [6], the temperature drops across the inner air film from equation (12) and the outer air film from equation (17) are plotted against air flow rate for a temperature difference $T_{ei} - T_o$ of $10 \text{ }^\circ\text{C}$ in Figures 5 and 6 respectively. The temperature difference across the inner air film at $1 \text{ m}^3/\text{m}^2\text{h}$ (typical for dynamic insulation in dwellings) is about $0.4 \text{ }^\circ\text{C}$ for a well insulated wall (thermal resistance of $6 \text{ m}^2\text{K/W}$) and over $1 \text{ }^\circ\text{C}$ for a poorly insulated wall ($1.2 \text{ m}^2\text{K/W}$). As the air flow increases the temperature difference increases and the difference between well insulated and poorly insulated walls decreases. For a swimming pool where the air flow through the wall could be greater than $5 \text{ m}^3/\text{m}^2\text{h}$ the wall surface temperature could be $2 \text{ }^\circ\text{C}$ lower than the environment temperature. When internal air flows to outside through the wall the inner film temperature difference decreases to zero. For the well insulated wall this temperature difference is practically zero for an air outflow of 1

$\text{m}^3/\text{m}^2\text{h}$. A similar pattern is observed for the temperature difference across the outer film except that the temperature difference decreases with increasing air flow. Figure 6 shows that with air flowing into the building the temperature difference across the outer air film could, for practical purposes, be neglected.

5. Comparison with Experimental Results

Crowther [4] has measured the performance of dynamic insulation using a hot box (Figure 7). His experiments were designed to measure the temperature profile through the wall as function of air flow and to establish whether dynamic insulation operating in the proflux mode with heat recovery does in fact achieve a net saving in energy. His results confirmed that the temperature profile is in accordance with equation (6) and that the energy used to maintain the hot box at a constant temperature of $38.9\text{ }^\circ\text{C}$ with air flowing in through wall A and out through the vent pipe in wall B is up to 7% less than that for a conventionally insulated box. Whilst Crowther's hot box experiments were not intended for investigating the temperature drop of the wall surface temperature with air flow the data presented in his thesis does enable a comparison with the above theory to be made.

Crowther's experimental apparatus is a 1.2 m long 0.5 m \times 0.5 m square section box made of plywood and covered with 100 mm of mineral wool insulation. The arrangement of the apparatus relevant to this discussion is as shown in Fig 7. Wall A is a tightly fitting batt of mineral wool and is air permeable. Air is pumped into a plenum on the left of wall A. The air flow

rate was measured by variable area flow meter. The pipe connecting the plenum to the heated chamber to the right of wall A is, in this instance, capped. The internal dimensions of the heated chamber are 0.5m X 0.5m X 0.5m. The chamber is heated by an electric cable underneath a thick aluminium plate forming the floor of the chamber. Air can flow out of the heated chamber through the vent pipe in wall B.

The mean temperature difference measured at one location (Fig 7) on the inner and outer surfaces are given in Table 1. The inside of the chamber was thermostatically controlled at 38.9 °C. The temperature of the air in the inlet plenum varied with the ambient conditions in the laboratory. The mean inlet temperature was 20.9 °C but the temperature ranged from 20.2 °C to 22.0 °C. The mean temperatures presented were adjusted so that they all relate to the same inlet temperature of 20.9 °C. This may be a possible cause of the discrepancy between theory and the experimental data.

Table 1

Air Flow	Measured		Calculated - 0.033		Calculated	
	$T_o - T_a$	$T_{ei} - T_L$	$T_o - T_a$	$T_{ei} - T_L$	R_a (m ²)	R_i (m ²)
0	0.9	2.2	0.92	2.15	0.186	0.434
0.6	0.8	2.3	0.88	2.24	0.214	0.335
1.5	0.5	2.8	0.82	2.37	0.220	0.269
3.0	0.3	3.7	0.73	2.59	0.348	0.209
4.5	0.1	4.6	0.64	2.83	0.417	0.177
6.0	0.0	5.3	0.56	3.07	--	0.152

From this data and assuming the thermal conductivity of mineral wool to be 0.033 W/mK, the outer and inner film resistances are estimated at zero air flow to be 0.186 m²K/W and 0.434 m²K/W respectively. The outer film resistance would be expected to be about the same as that quoted by CIBSE for an internal surface since the hot box is in a laboratory. The high film resistance on the inside of the chamber may indicate that the heat transfer processes within the box do replicate exactly those occurring with in a room. Two possible hypotheses will be explored. The first is the film resistance, as measured at zero air flow, is independent of air flow and so can be used to predict the surface temperatures at higher air flows. This seems a reasonable proposal since the heat transfer processes taking place at the surface of the permeable wall would not be expected to be significantly altered by the relatively slow speed of the air effusing from the wall. The theoretically predicted film temperature differences (Table 1) are calculated on the further assumption that air flow over the whole area of wall A is uniform. The hot box design does not ensure that this assumption is met and is a further

explanation of why the theoretical predictions vary significantly from the experimental data, especially at high air flows. Nevertheless the experimental data confirm the general trend predicted by theory.

The second hypothesis is to treat the measured temperatures as being reliable and to infer the implied film resistance as a function of air flow. From Table 1 the implications of this hypothesis are that the inner film resistance decreases as the air flowing out of the wall increases whereas the outer film resistance increases. The effect of air flowing into and out of a porous wall would be to decrease and increase the thickness of the laminar sublayer at the wall respectively. This would, in turn, cause the inner film resistance to increase with flow rate and the ambient film resistance to decrease. Whilst the magnitudes of the film resistances are reasonable in the circumstances, the second hypothesis, for the above reason, is not entirely convincing.

The experiments on the Cambridge hot box were carried out with the purpose of measuring the temperature profile through the wall rather than looking specifically at the temperature drop across the air films. It is therefore proposed to carry out further experimental work to measure the film resistances and elucidate the heat transfer mechanisms taking place. This is essential to understanding the interaction of a dynamically insulated wall with the internal and external environments.

6. Conclusions

Consideration of the air films on either side of a dynamically insulated wall has provided insight into the heat transfer processes at the wall surfaces. The boundary condition that comes closest to predicting the variation of the surface temperature with air flow is to assume that the conduction heat flux at the wall surface, rather than the net heat flux is equal to the flux incident on the wall from global environmental temperature T_{ei} . The theory predicts that a well insulated wall will have a higher inner surface and lower outer surface temperature than a poorly insulated wall for the same air flow. A very practical result from this work is that it demonstrates that, when assessing the relative change in the heat loss of dynamic insulation over the static equivalent, then both the outer and inner air films may neglected. The effect of the air films cannot be neglected when calculating the surface temperatures and how they may affect human comfort.

Comparison of predictions of the temperature drop across the inner and outer air films with data from a hot box experiment show that the theory predicts the general trend of decreasing surface temperatures with increasing air flow. However, further experimental work is required to confirm the magnitude of the changes.

Acknowledgements

This work is the result of a collaborative effort between The Scott Sutherland School of Architecture at The Robert Gordon University, and The Department of Engineering at The University of Aberdeen. It is funded by the Engineering

and Physical Sciences Research Council, UK. Dr D Crowther is thanked for providing the diagram of his hot box.

References

1. B. Taylor, D. A. Cawthorne, M. S. Imbabi., *Analytical Investigation of the Dynamic and Diffusive Behaviour of Building Envelopes*, to be published.
2. I. D. Morrison, A. N. Karagiozis, K. Kumaran., *Thermal Performance of a Residential Dynamic Wall*, Thermal Performance of the Exterior Envelopes of Buildings V, Proc. Of the ASHRAE/DOE/BTEC Conf., 7- 10 Dec 1992, Florida
3. A. Dalehaug, Dynamic Insulation in Walls, Research Report No 53, Hokkaido Prefectural Cold Region Housing and Urban Research Institute, 1993.
4. D. R. G. Crowther, University of Cambridge, Ph.D. Thesis, 1995.
5. H. Bartussek, *Poren-Luftung (Porous Ceilings)*, Osterreichisches Kuratorium fur Landtechnik, Vienna, 1981.
6. CIBSE Guide Volume A: Design Data, Chartered Institution of Building Services Engineers, 1986.
7. M. G. Davies, Rad-air Temperature: The Global Temperature in an Enclosure, Building Serv. Eng Res. Technol. 10(3) 89-104, 1989.

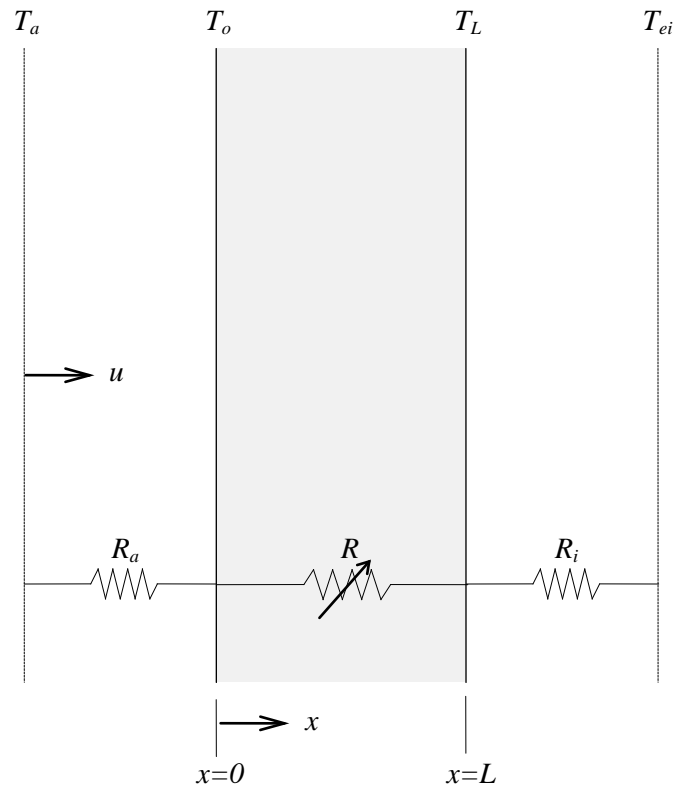

Figure 1: Dynamic Wall Element.

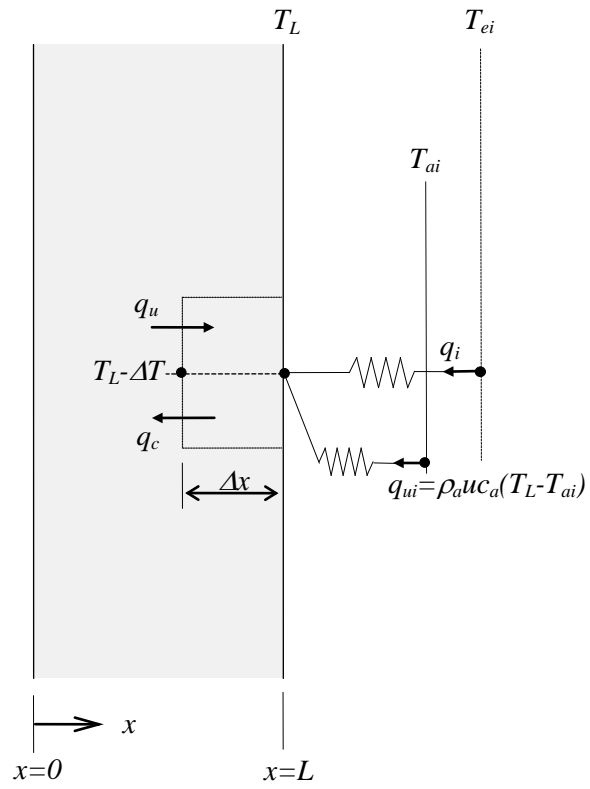

Figure 2: Energy Balance at Inner Surface.

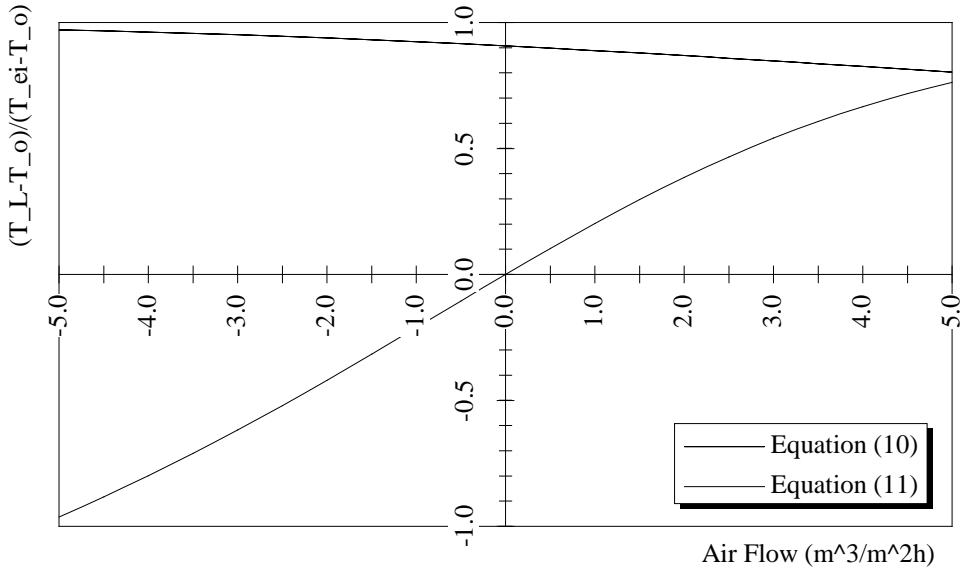

Figure 3: Wall Surface Temperature

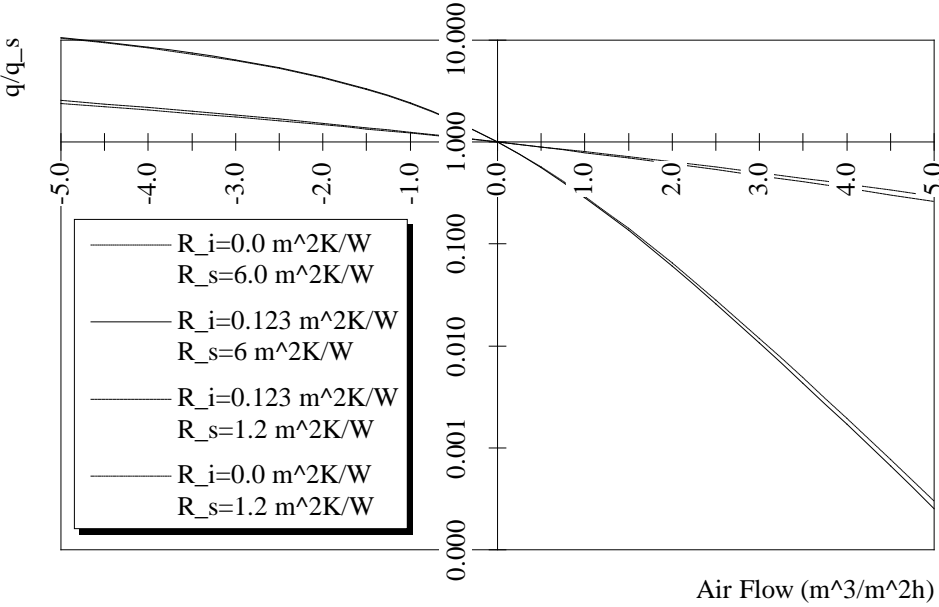

Figure 4: Ratio of Dynamic to Diffusive Heat Flux

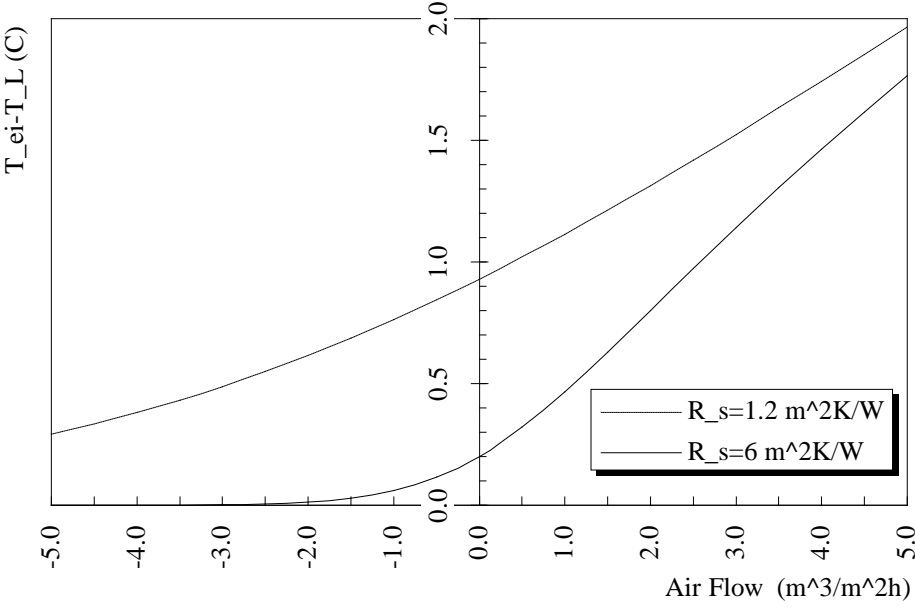

Figure 5: Inner Film Temperature Difference

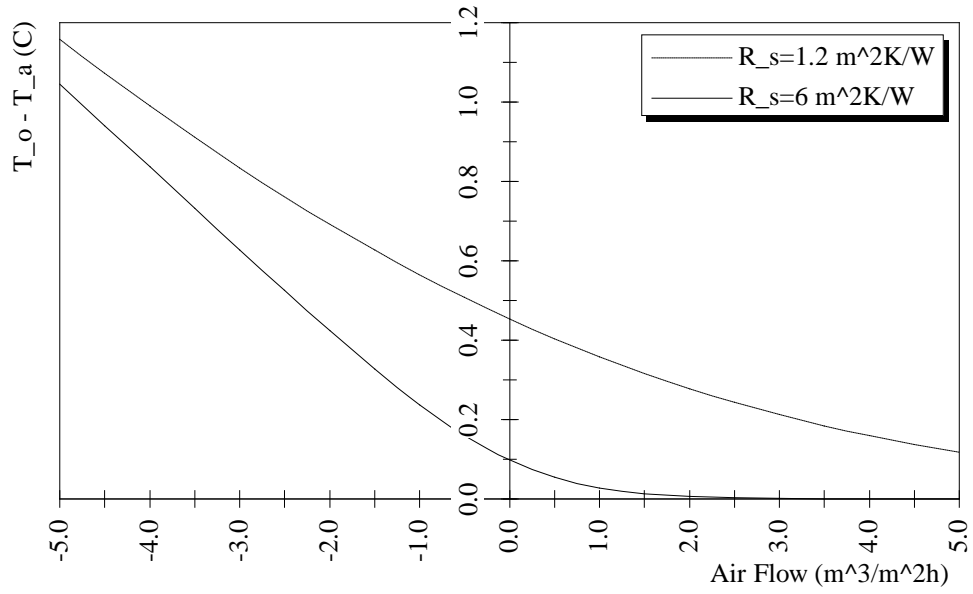

Figure 6: Outer Film Temperature Difference

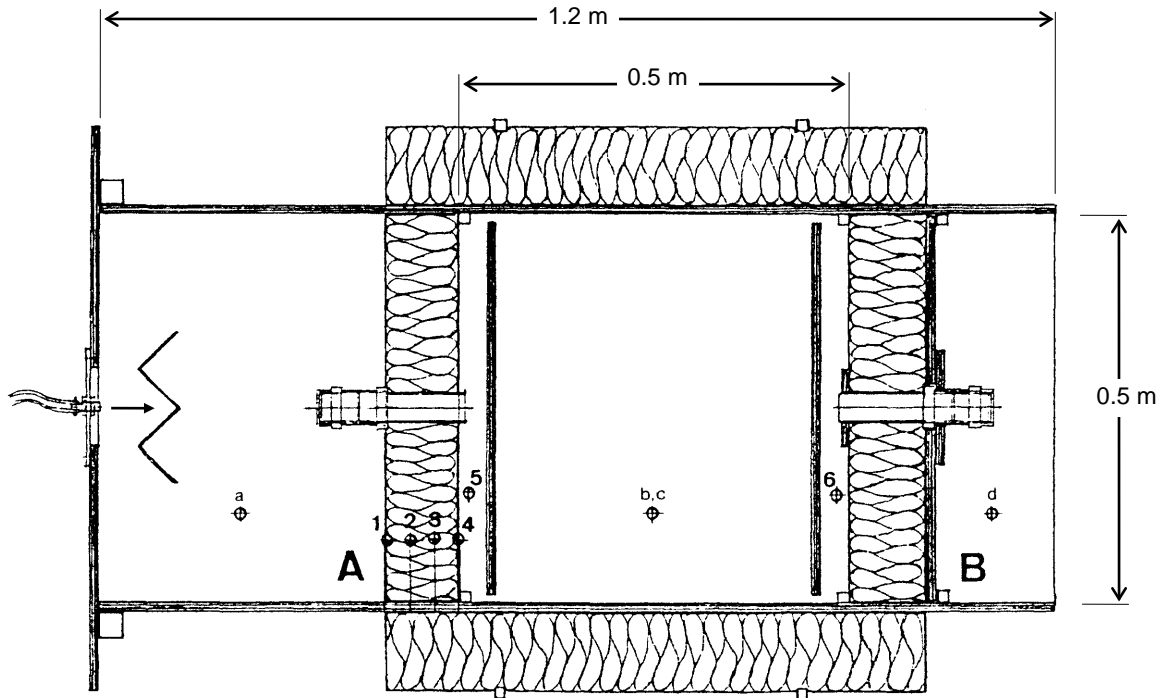

Figure 7: Plan view of Cambridge hot box [4]